

# SISTEMAS DE CALEFACCION

---

INSTALACIONES | 2022 – CIVIL



## 2 TEMARIO

---

- Confort. Confort Térmico . Ábaco psicométrico. Zona de confort
- Clasificación de los sistemas
- Ventajas y desventajas comparativas
  - Centrales vs individuales
  - Agua – Aire - Mixtos

# 3 CLASIFICACIÓN

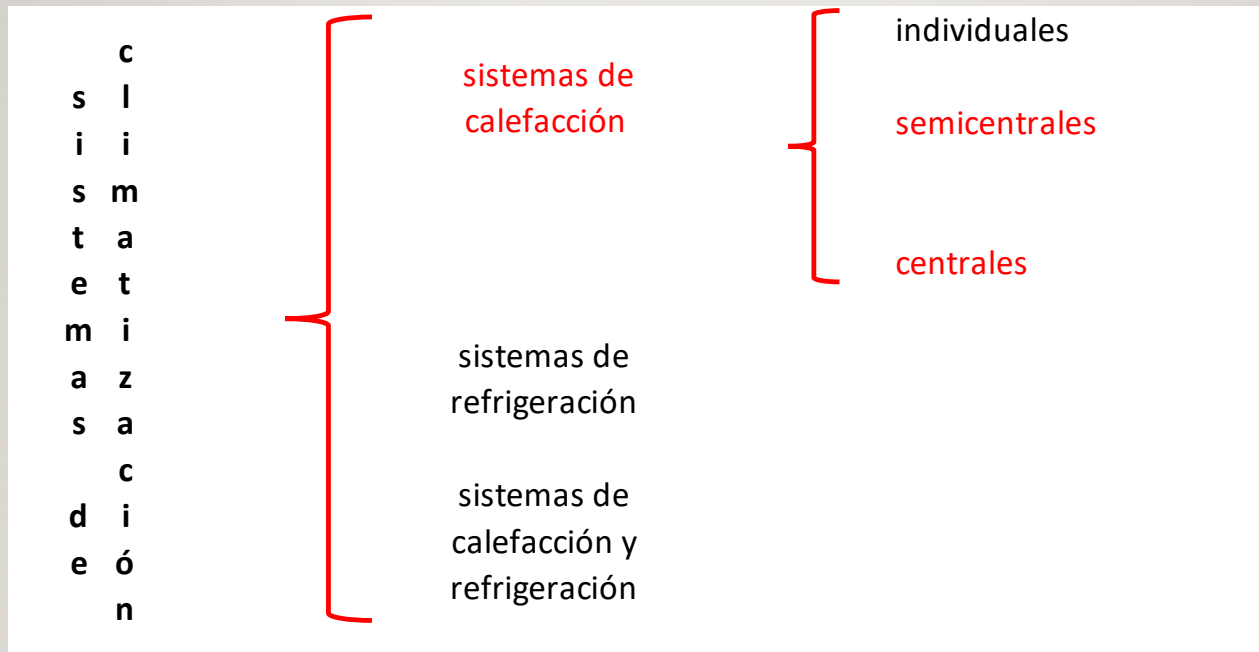

# 4 CLASIFICACIÓN

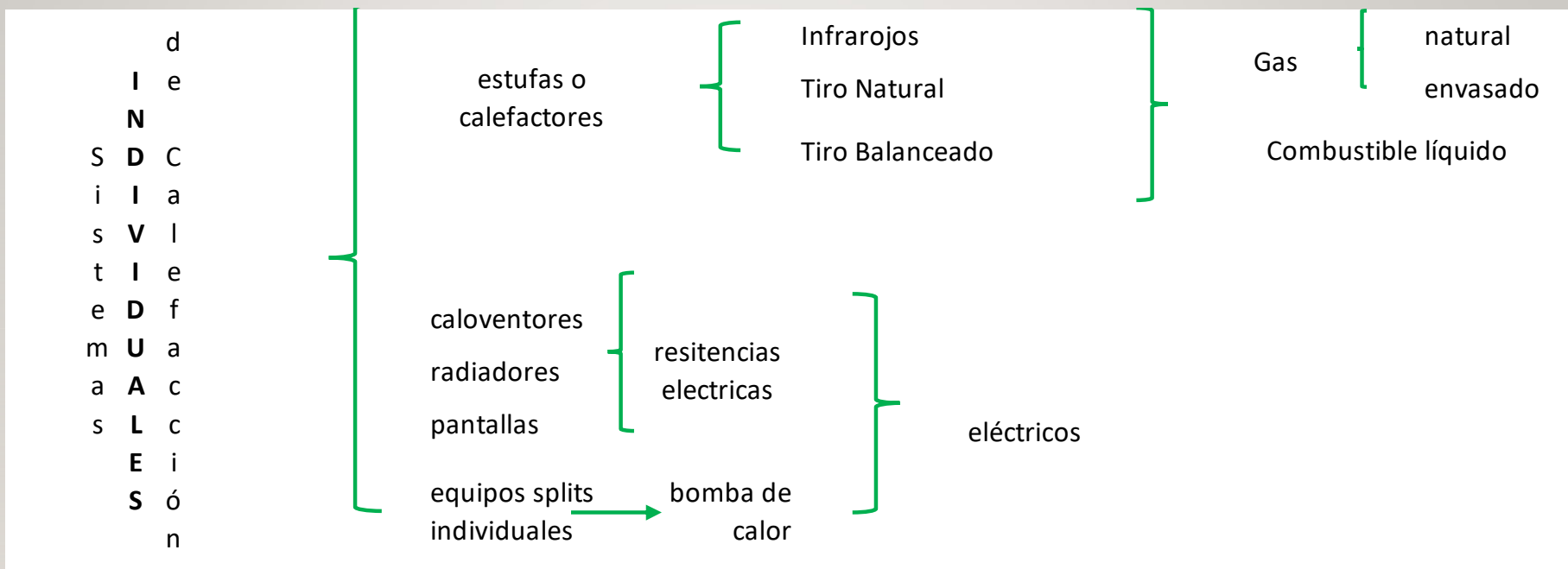

# 5 CLASIFICACIÓN

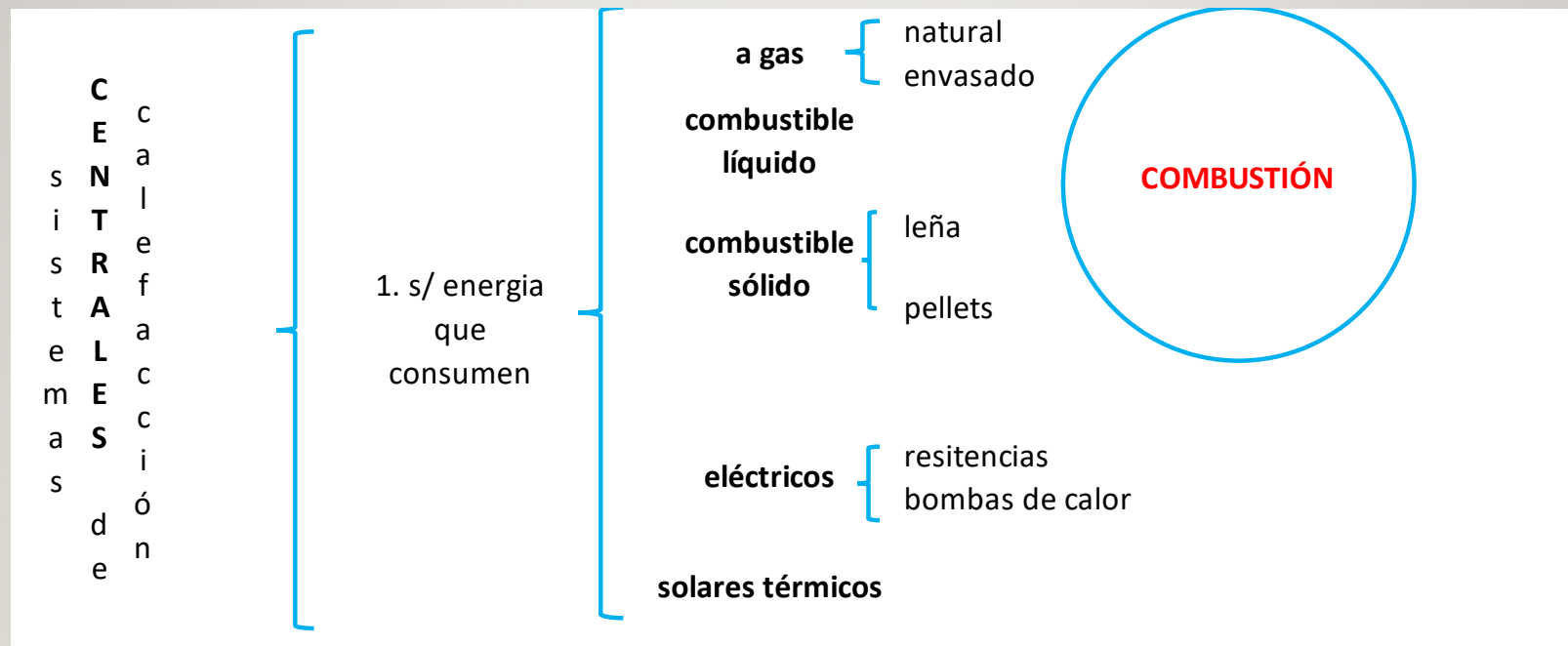

# 6 CLASIFICACIÓN

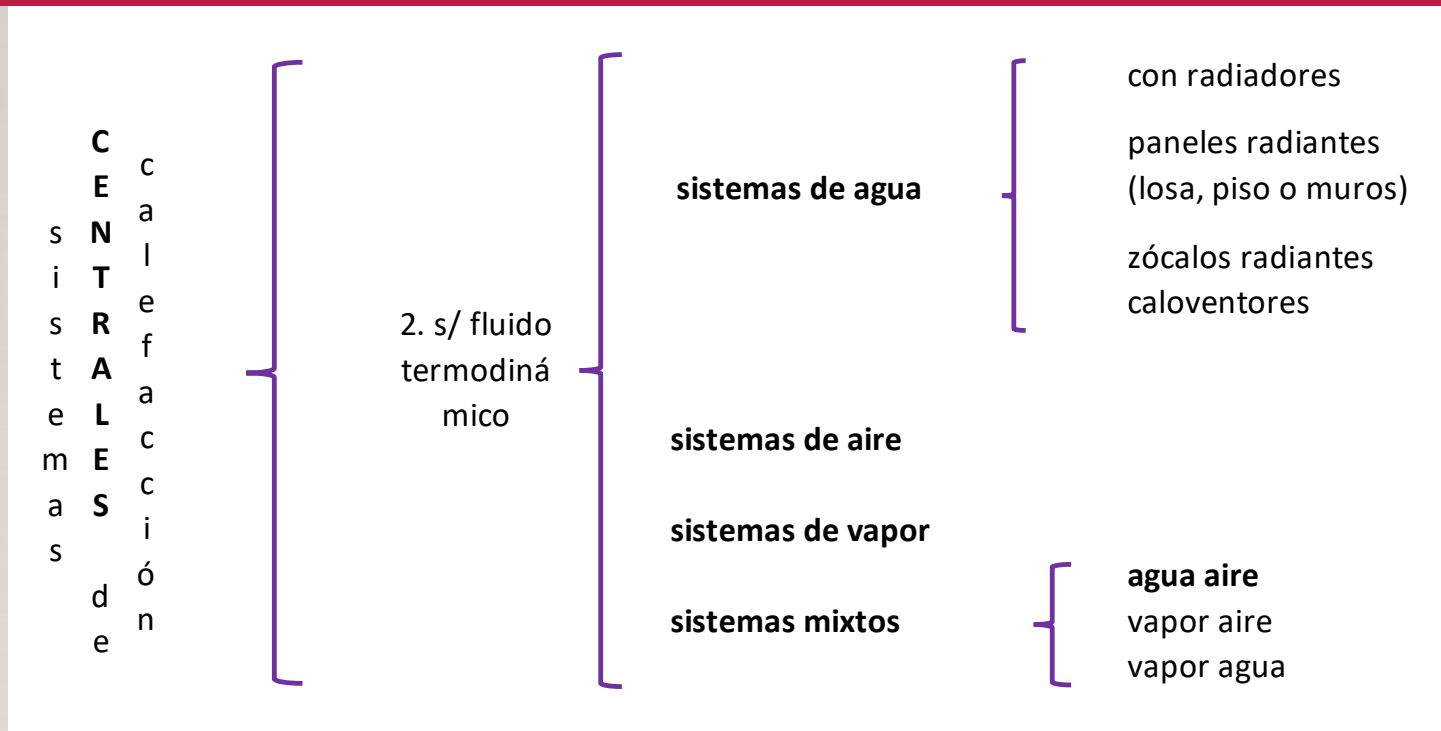

## 7 CALEFACCIÓN CON EQUIPOS INDIVIDUALES

- Tiro balanceado

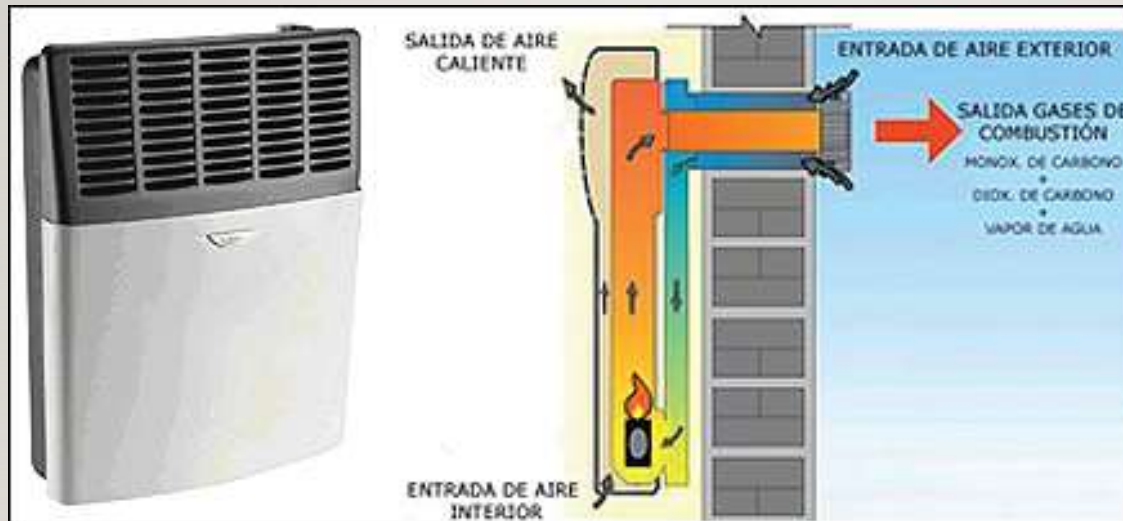

## 8 CALEFACCIÓN CON EQUIPOS INDIVIDUALES

- Tiro Directo ( cámara abierta)
- 





## 9 CALEFACCIÓN CON EQUIPOS INDIVIDUALES

---

- Infrarojas



# 10 CALEFACCIÓN CON EQUIPOS INDIVIDUALES

---

- Eléctricas: Cuarzo

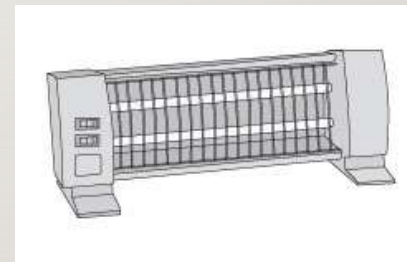

## II CALEFACCIÓN CON EQUIPOS INDIVIDUALES

---

- Eléctricas: halógenas



## 12 CALEFACCIÓN CON EQUIPOS INDIVIDUALES

---

- Eléctricas: caloventores



## 13 CALEFACCIÓN CON EQUIPOS INDIVIDUALES

---

- Eléctricas: radiadores de aceite



## 14 CALEFACCIÓN CON EQUIPOS INDIVIDUALES

---

- Con combustible líquido



# 15 CALEFACCIÓN CENTRAL

- Agua con radiadores

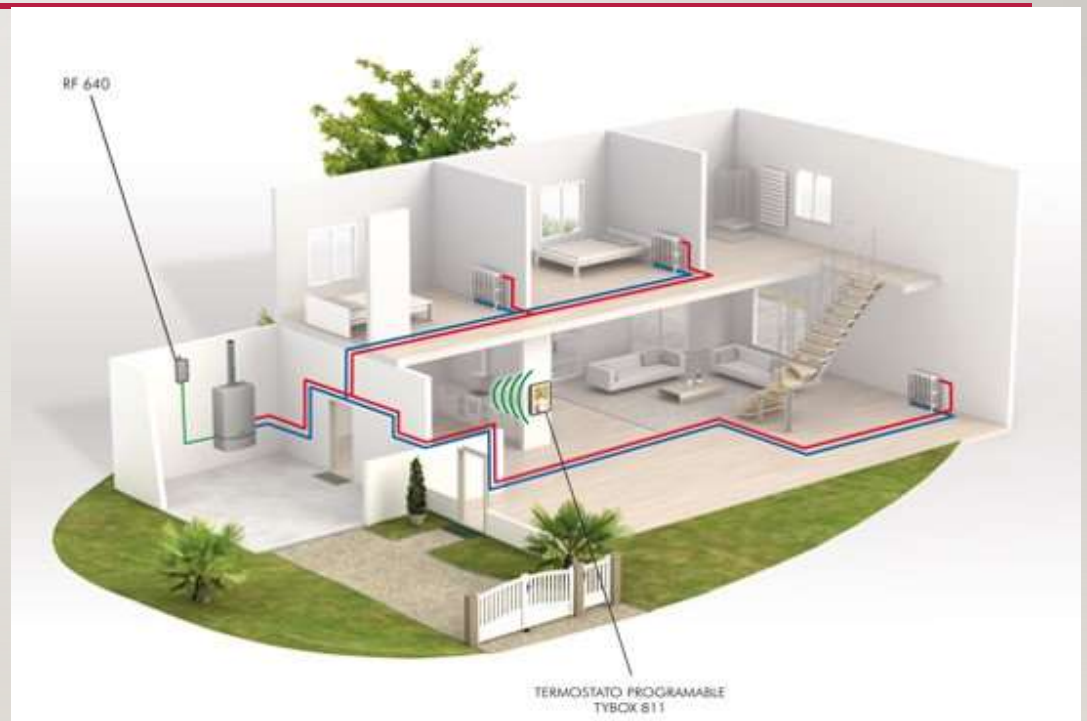

# 16 CALEFACCIÓN CENTRAL

---

- Agua con paneles ( piso, muro o techo)

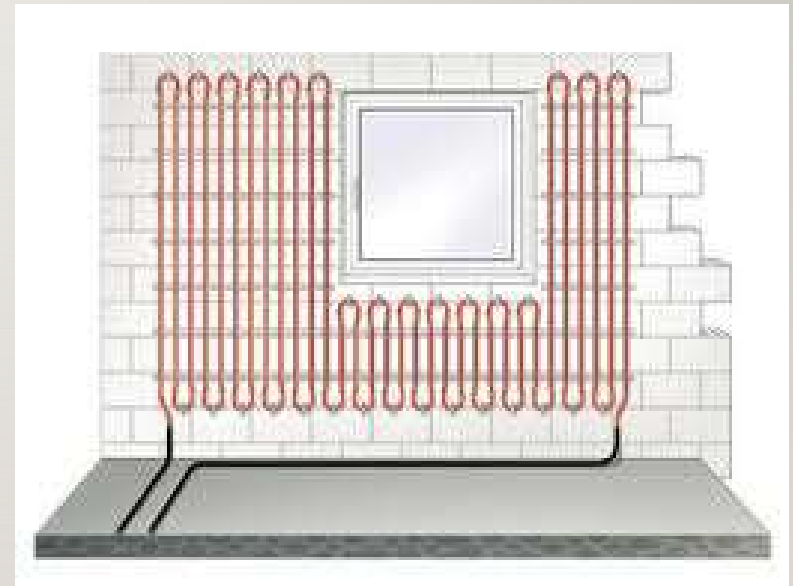
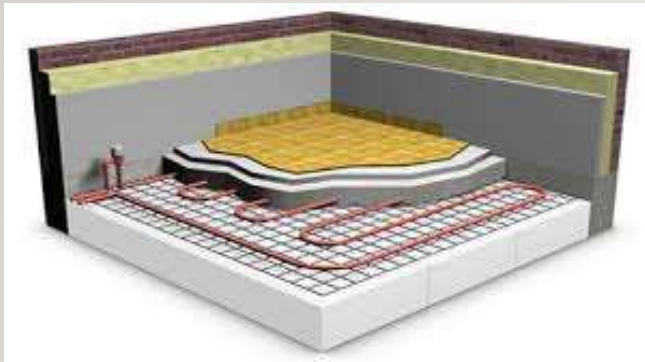



# 17 CALEFACCIÓN CENTRAL

---

- Calderas



# 18 CALEFACCIÓN CENTRAL

---

- Por aire: calefactor

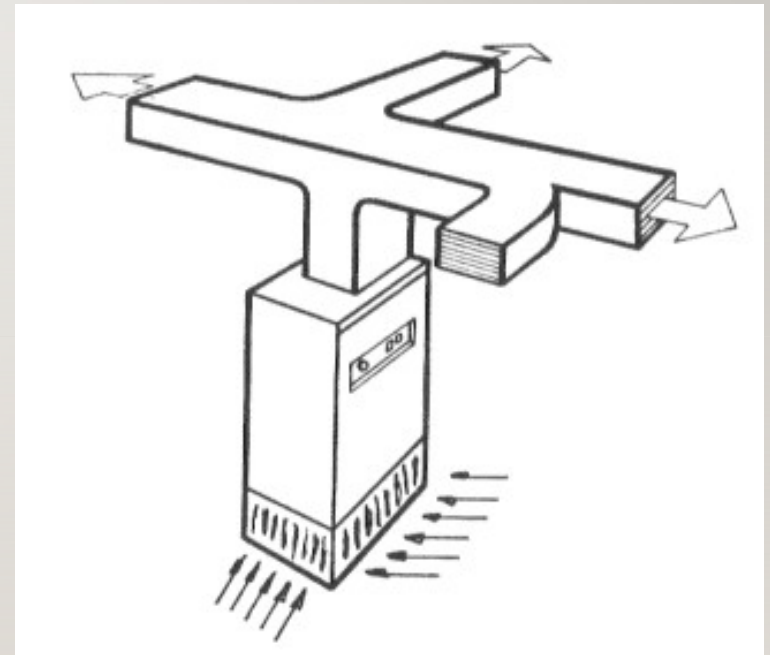

## 19 CALEFACCIÓN CENTRAL

---

- Equipo tipo RoofTop (aire)



## 20 CALEFACCIÓN CENTRAL

---

- Sistema central por aire



## 21 CALEFACCIÓN CENTRAL

---

- Sistema central por aire: conductos



## 22 CALEFACCIÓN CENTRAL

- Sistemas mixto:AGUA AIRE

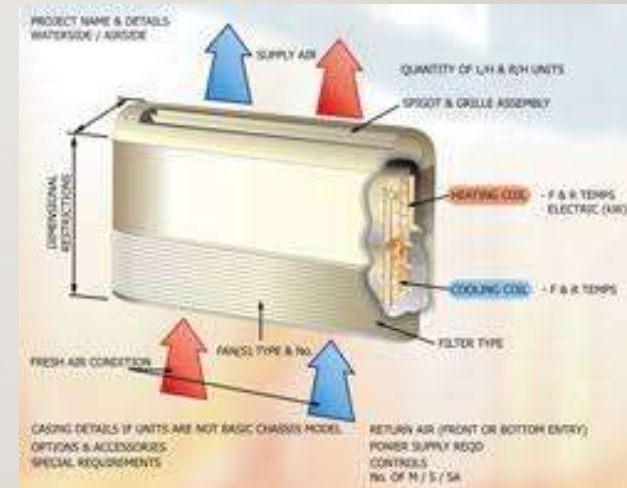

## 23 CALEFACCIÓN CENTRAL

- Sistema Mixto AGUA AIRE. Equipos fan coils

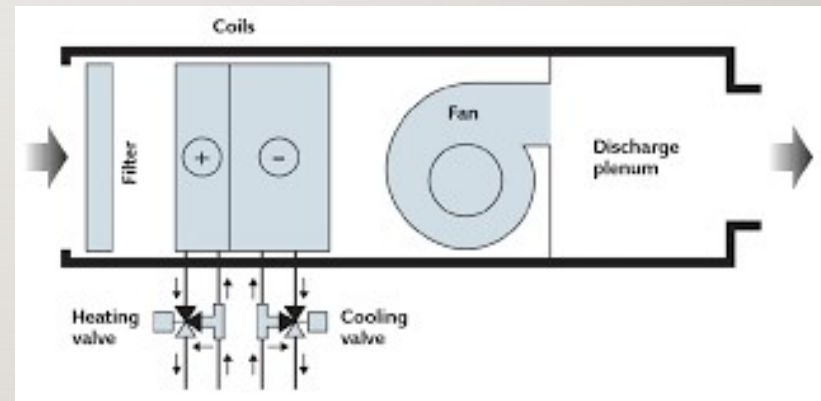

## 24 CALEFACCIÓN CENTRAL

---

- Sistema Mixto AGUA AIRE. Equipos fan coils centrales (conductos)

