

Protection of Metals in Concrete Against Corrosion

Reported by ACI Committee 222

Brian B. Hope
Chairman

Charles K. Nmai
Secretary

Theodore Bremner
John Broomfield
Kenneth Clear
James Clifton
Steven Daily
Marwan Daye
Edwin Decker
Richard Didelot
Bernard Erlin
John Grant
Ping Gu
Trey Hamilton, III

Kenneth Hover
Thomas Joseph
Mohammad Khan
David Manning
David McDonald
Edward McGettigan
Richard Montani
Mahamad Nagi
Theodore Neff
Keith Pashina
William Perenchio

Randall Poston
Robert Price*
D. V. Reddy
Arpad Savoly
William Scannell
Morris Schupack
Khaled Soudki
David Trejo
Thomas Weil
Jeffrey West
Richard Weyers

*Deceased

This report reflects the state of the art of corrosion of metals, and especially reinforcing steel, in concrete. Separate chapters are devoted to the mechanisms of the corrosion of metals in concrete, protective measures for new concrete construction, procedures for identifying corrosive environments and active corrosion in concrete, and remedial measures.

Keywords: admixture; aggregate; blended cement; bridge deck; calcium chloride; carbonation; cathodic protection; cement paste; coating; corrosion; corrosion inhibitor; cracking; deicer; deterioration; durability; parking structures; polymers; portland cements; prestressed concrete; prestressing steels; protective coatings; reinforced concrete; reinforcing steels; repairs; resins; resurfacing; spalling; waterproof coatings; zinc coatings.

ACI Committee Reports, Guides, Standard Practices, and Commentaries are intended for guidance in planning, designing, executing, and inspecting construction. This document is intended for the use of individuals who are competent to evaluate the significance and limitations of its content and recommendations and who will accept responsibility for the application of the material it contains. The American Concrete Institute disclaims any and all responsibility for the stated principles. The Institute shall not be liable for any loss or damage arising therefrom.

Reference to this document shall not be made in contract documents. If items found in this document are desired by the Architect/Engineer to be a part of the contract documents, they shall be restated in mandatory language for incorporation by the Architect/Engineer.

CONTENTS

Chapter 1—Introduction, p. 222R-2

- 1.1—Background
- 1.2—Scope

Chapter 2—Mechanism of corrosion of steel in concrete, p. 222R-3

- 2.1—Introduction
- 2.2—Principles of corrosion
- 2.3—Reinforcing bar
- 2.4—The concrete environment

Chapter 3—Protection against corrosion in new construction, p. 222R-9

- 3.1—Introduction
- 3.2—Design and construction practices
- 3.3—Methods of excluding external sources of chloride ion from concrete
- 3.4—Corrosion control methods

Chapter 4—Procedures for identifying corrosive environments and active corrosion in concrete, p. 222R-18

- 4.1—Introduction
- 4.2—Condition evaluation of reinforced concrete structures
- 4.3—Corrosion evaluation methods
- 4.4—Concrete evaluation test methods

ACI 222R-01 supersedes ACI 222R-96 and became effective September 25, 2001. Copyright © 2001, American Concrete Institute.

All rights reserved including rights of reproduction and use in any form or by any means, including the making of copies by any photo process, or by electronic or mechanical device, printed, written, or oral, or recording for sound or visual reproduction or for use in any knowledge or retrieval system or device, unless permission in writing is obtained from the copyright proprietors.

Chapter 5—Remedial measures, p. 222R-28

- 5.1—Introduction
- 5.2—General
- 5.3—Applicability
- 5.4—The remedies and their limitations
- 5.5—Summary

Chapter 6—References, p. 222R-32

- 6.1—Referenced standards and reports
- 6.2—Cited references
- 6.3—Other references

CHAPTER 1—INTRODUCTION**1.1—Background**

The corrosion of metals, especially reinforcing steel, in concrete has received increasing attention in recent years because of its widespread occurrence in certain types of structures and the high cost of repairing the structures. The corrosion of steel reinforcement was first observed in marine structures and chemical manufacturing plants.¹⁻³ Recently, numerous reports of its occurrence in bridge decks, parking structures, and other structures exposed to chlorides have made the problem particularly prominent. Extensive research on factors contributing to steel corrosion has increased our understanding of the mechanics of corrosion, especially concerning the role of chloride ions. It is anticipated that the application of the research findings will result in fewer instances of corrosion in new reinforced concrete structures and improved methods of repairing corrosion-induced damage in existing structures. For these improvements to occur, the research information should be disseminated to individuals responsible for the design, construction, and maintenance of concrete structures.

Concrete normally provides reinforcing steel with excellent corrosion protection. The high-alkaline environment in concrete creates a tightly adhering film that passivates the steel and protects it from corrosion. Because of concrete's inherent protective attributes, corrosion of reinforcing steel does not occur in the majority of concrete elements or structures. Corrosion of steel, however, can occur if the concrete does not resist the ingress of corrosion-causing substances, the structure was not properly designed for the service environment, or the environment is not as anticipated or changes during the service life of the structure.

While several types of metals may corrode under certain conditions when embedded in concrete, the corrosion of steel reinforcement is the most common and is of the greatest concern, and, therefore, is the primary subject of this report.

Exposure of reinforced concrete to chloride ions is the major cause of premature corrosion of steel reinforcement. Corrosion can occur, however, in some circumstances in the absence of chloride ions. For example, carbonation of concrete reduces concrete's alkalinity, thereby permitting corrosion of embedded steel. Carbonation is usually a slow process in concretes with a low water-cementitious materials ratio (w/cm). Carbonation-induced corrosion is not as common as corrosion induced by chloride ions.

Chloride ions are common in nature and very small amounts are normal in concrete-making materials. Chloride ions may also be intentionally added into the concrete, most often as a constituent of accelerating admixtures. Dissolved chloride ions may also penetrate hardened concrete in structures exposed to marine environments or to deicing salts.

The rate of corrosion of steel reinforcement embedded in concrete is influenced by environmental factors. Both oxygen and moisture must be present if electrochemical corrosion is to occur. Reinforced concrete with significant gradients in chloride-ion content is vulnerable to macrocell corrosion, especially when subjected to cycles of wetting and drying. This condition often occurs in highway bridges and parking structures exposed to deicing salts and in structures in marine environments. Other factors that affect the rate and level of corrosion are heterogeneity in the concrete and the reinforcing steel, pH of the concrete pore water, carbonation of the portland cement paste, cracks in the concrete, stray currents, and galvanic effects due to contact between dissimilar metals. Design features and construction practices also play an important role in the corrosion of embedded steel. Mixture proportions of the concrete, thickness of concrete cover over the reinforcing steel, crack-control measures, and implementation of measures designed specifically for corrosion protection are some of the factors that help control the onset and rate of corrosion.

Deterioration of concrete due to corrosion of the reinforcing steel results because the solid products of corrosion (rust) occupy a greater volume than the original steel and exert substantial expansive stresses on the surrounding concrete. The outward manifestations of the rusting include staining, cracking, and spalling of the concrete. Concurrently, the cross-sectional area of the reinforcing steel is reduced. With time, structural distress may occur either because of loss of bond between the reinforcing steel and concrete due to cracking and spalling or as a result of the reduced steel cross-sectional area. This latter effect can be of special concern in structures containing high-strength prestressing steel in which a small amount of metal loss could induce failure.

Research on corrosion has not produced a carbon steel or other type of reinforcement that will not corrode when used in concrete and which is both economical and technically feasible. Serious consideration is being given to the use of stainless steel reinforcement for structures exposed to chlorides⁴ and several structures have been built using stainless steel. In addition, practice and research indicate the need for quality concrete, careful design, good construction practices, and reasonable limits on the amount of chlorides in the concrete mixture ingredients. Measures that are being used and further investigated include the use of corrosion inhibitors, protective coatings on the reinforcing steel, and cathodic protection. In general, each of these measures has been successful. Problems resulting from corrosion of embedded reinforcing steel and other metals, however, have not been eliminated.

1.2—Scope

This report discusses the factors that influence corrosion of reinforcing steel in concrete, measures for protecting em-

bedded reinforcing steel in new construction, techniques for detecting corrosion in structures in service, and remedial procedures. Consideration of these factors and application of the discussed measures, techniques, and procedures should assist in reducing the occurrence of corrosion and result, in most instances, in the satisfactory performance of reinforced and prestressed concrete structural members.

CHAPTER 2—MECHANISM OF CORROSION OF STEEL IN CONCRETE

2.1—Introduction

This chapter describes the thermodynamics and kinetics of the corrosion of steel embedded in concrete. Subsequent sections explain the initiation of active corrosion by chlorides, carbonation of the concrete cover, and the rate-controlling factors for corrosion after it has been initiated. Finally, the influence of reinforcement type and of the concrete environment are discussed.

2.2—Principles of corrosion

2.2.1 The corrosion process—The corrosion of steel in concrete is an electrochemical process; that is, it involves the transfer of charge (electrons) from one species to another. For an electrochemical reaction to occur (in the absence of an external electrical source) there must be two half-cell reactions—one capable of producing electrons (the anodic reaction, the oxidation of iron, [Fe], to form ferrous ions) and one capable of consuming electrons (the cathodic reaction, the reduction of oxygen to form hydroxyl ions, [OH⁻]). When the two reactions occur at widely separated locations, they are termed a macrocell; when they occur close together, or essentially at the same location, they are termed a microcell.

For steel embedded in concrete, the anodic half-cell reactions involve the oxidation or dissolution of iron, namely

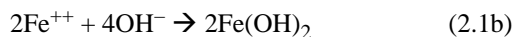

and the most likely cathodic half-cell reactions are

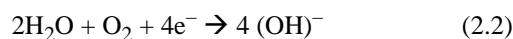

Which of these anodic and cathodic reactions will actually occur in any specific case depends on the availability of oxygen and on the pH of the cement paste pore solution in the vicinity of the steel. This is shown by the Pourbaix diagram,⁵ illustrated in Fig. 2.1, which delineates the thermodynamic areas of stability for each of the species involved in the previously mentioned reactions as a function of

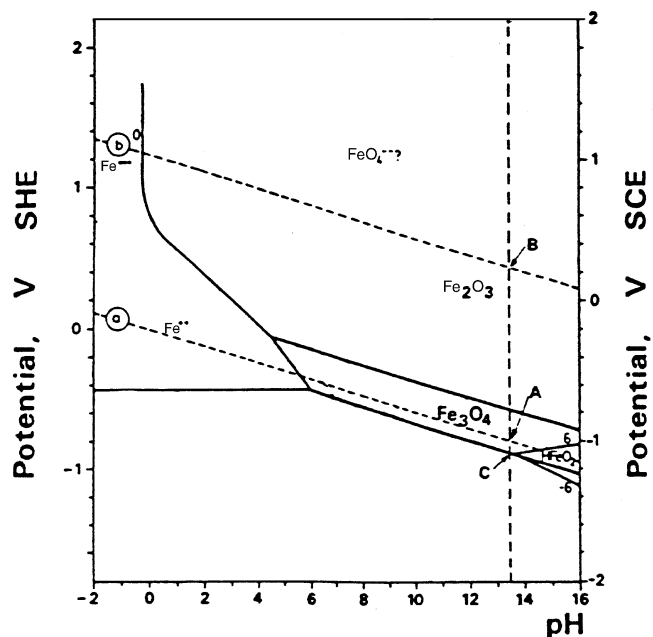

Fig. 2.1—Simplified Pourbaix diagram showing the potential pH ranges of stability of the different phases of iron in aqueous solutions.⁵

electrochemical potential* and pH of the environment. For the reaction shown in Eq. (2.2) to occur, the potential must be lower than that indicated by the upper dashed line, whereas the reaction shown in Eq. (2.3) can only proceed at potentials below the lower dashed line. In general, if all other factors are kept constant, the more oxygen that is available, the more positive (anodic) will be the electrochemical potential.

For sound concrete, the pH of the pore solution ranges from 13.0 to 13.5, within which the reactions shown in Eq. (2.1a) and (2.1b) are the most likely anodic reactions. In the absence of any other factors, the iron oxides, Fe₃O₄ and Fe₂O₃ or hydroxides of these compounds, will form as solid phases and may develop as a protective (passive) layer on the steel, described as follows. If the pH of the pore solution is reduced, for example, by carbonation or by a pozzolanic reaction, the system may be shifted to an area of the Pourbaix diagram in which these oxides do not form a protective layer and active dissolution is possible. Theoretically, active corrosion could also be induced by raising the pH to a value at which the reaction shown in Eq. (2.1d) can take place and for which HFeO₂⁻ is the thermodynamically stable reaction product. The reaction shown in Eq. (2.1c) can also take place at normal concrete pH at elevated temperatures (> 60 C, 140 F).⁶ No examples of this reaction have been reported.

2.2.2 Nature of the passive film—A passive film can be relatively thick and inhibit active corrosion by providing a

*The electrochemical potential is a measure of the ease of electron charge transfer between a metal and its environment, in this case, between the steel and the cement paste pore solution. It is a property of the steel/concrete interface and not of the steel itself. It is not possible to determine the absolute value of the potential and, therefore, it is necessary to measure the potential difference between the steel surface and a reference electrode. This might be a standard hydrogen electrode (SHE), a saturated calomel electrode (SCE), or a Cu/CuSO₄ electrode (CSE). The value of the potential in a freely corroding system is commonly known as the corrosion potential, the open circuit potential, or the free potential.

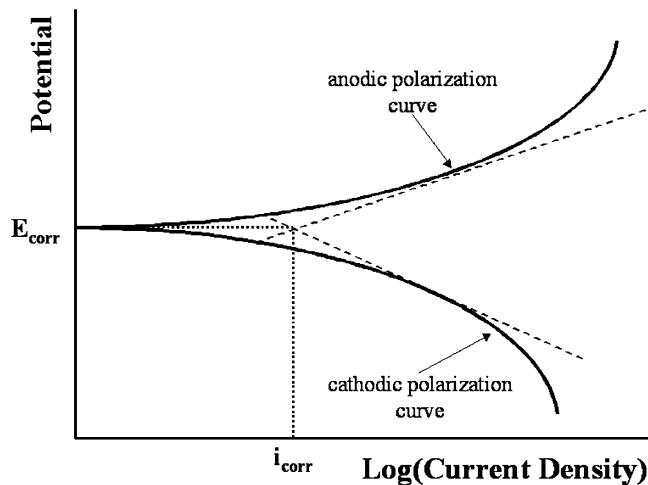

Fig. 2.2—Schematic polarization curve for an actively corroding system without any diffusion limitations.

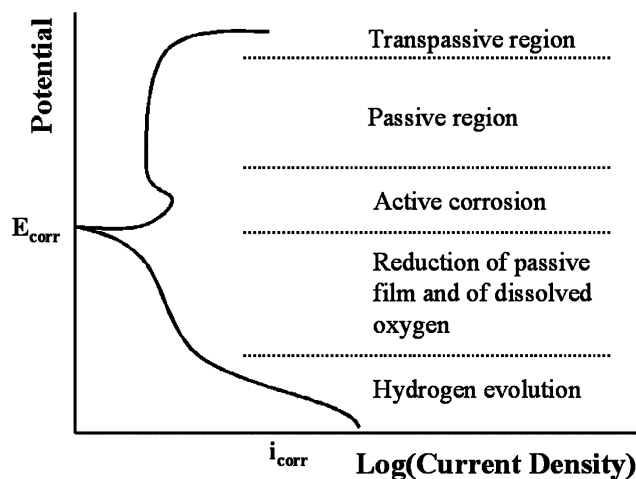

Fig. 2.3—Schematic polarization curve for passive system with limited access of oxygen.

diffusion barrier to the reaction product of the reacting species (Fe and O_2). Alternatively, and more commonly, it may be thin, often less than a molecular monolayer. In this case, the oxide molecules simply occupy the reactive atom sites on the metal surface, preventing the metal atoms at these locations from dissolving. A passive film does not actually stop corrosion; it reduces the corrosion rate to an insignificant level. For steel in concrete, the passive corrosion rate is typically $0.1 \mu\text{m/yr}$;⁷ without the passive film, the steel will corrode at rates at least three orders of magnitude higher than this.

2.2.3 The kinetics of corrosion—All metals, except gold and platinum, are thermodynamically unstable under normal atmospheric conditions and will eventually revert to their oxides (or other compounds), as indicated for iron in the Pourbaix diagram in Fig. 2.1. Therefore, the information of importance to the engineer who would use a metal is not whether the metal will corrode, but how fast the corrosion will occur. The corrosion rate can be determined as a corrosion current by measuring the rate at which electrons are removed from the iron in the anodic reactions described previously.

The corrosion current can be converted to a rate of loss of metal from the surface of the steel by Faraday's law

$$M = \frac{ItA_w}{nF} \quad (2.4)$$

where

M = mass of metal dissolved or converted to oxide, g;

I = current, A;

t = time, s;

A_w = atomic weight;

n = valency; and

F = Faraday's constant (96,500 coulombs/equivalent mass).

By dividing by the density, the mass can be converted to thickness of the dissolved or oxidized layer, and for iron (or steel): $1 \mu\text{A/cm}^2 = 11.8 \mu\text{m/yr}$. The current density, which is equivalent to the net current divided by the electrode area, however, cannot be determined directly. This is because the requirement of a charge balance means that the rates of production and consumption of electrons by the anodic and cathodic half-cell reactions, respectively, are always equal and, therefore, no net current can be measured. Consequently, to determine the corrosion current, the system must be displaced from equilibrium by applying an external potential and measuring the resultant net current* (potentiostatic measurements). The difference between the applied potential E , and the original corrosion potential E_{corr} , is termed the polarization and given the symbol η .

In the absence of passivity, the net current would increase with anodic polarization as shown by the upper curve in Fig. 2.2, and cathodic polarization would result in the lower curve. Tafel⁸ has shown that for values of η in the range ± 100 to 200 mV, η is directly proportional to the logarithm of the current density

$$\eta = a + b \log(i) \quad (2.5)$$

where

a = constant; and

b = Tafel slope

A value of the corrosion current density i_{corr} can be obtained by extrapolating the linear part of the curves to E_{corr} , as shown by the dashed lines in Fig. 2.2.

For steel in concrete, however, the chemical protection given to the steel by the formation of a passive film reduces the anodic current density by several orders of magnitude, as shown in Fig. 2.3. The transition from the active corrosion part of the polarization curve to the passive region occurs as a result of the formation of a passive metal oxide film. Moreover, the physical barrier of the concrete limits the oxygen access for the cathodic reaction and can result in a decrease in the cathodic current, also illustrated in Fig. 2.3. Both of these factors significantly reduce the corrosion rate. They also limit the accuracy by which the actual corrosion rate can be determined, because the linear part of each curve no

* Alternatively, apply a known current and measuring the resulting shift in electrochemical potential (galvanostatic measurements).

longer exists. This lack of accuracy is irrelevant, however, because a precise knowledge of the passive corrosion rate* is of no practical interest. Polarization curves (Tafel plots) for reinforcing steel in concretes of different qualities have been documented by Al-Tayyib and Khan.⁹

As illustrated in Fig. 2.3, the value of the net anodic current density is approximately constant over a wide range of potential but increases at high potentials. This increase, referred to as transpassive dissolution, can result from dielectric breakdown of the passive film. It can also be due to the potential being above that indicated by the upper dashed line in Fig. 2.1. At these potentials, O₂ can be evolved at atmospheric pressures by the reverse of the reaction shown in Eq. (2.2) or by the hydrolysis of water

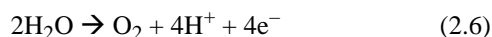

adding a second anodic reaction to that of the (passive) corrosion of iron. A third reaction would involve the corrosion of steel into Fe⁺⁶, which is an anodic reaction.⁸

2.2.4 Initiation of active corrosion—Active corrosion of steel in concrete must be preceded by the breakdown of the protective passive film. This can occur over the whole surface of the steel because of a general change in the thermodynamic conditions, or locally due to localized chemical attack or mechanical failure. The former is usually a result of a decrease in pH to the level at which the passive film is no longer stable. The latter is usually caused by attack by aggressive ions such as chlorides, but could result from cracking in the concrete cover.

2.2.4.1 Corrosion initiation by chlorides—The most common cause of initiation of corrosion of steel in concrete is the presence of chloride ions. The source of chlorides may be admixtures, contaminants, marine environments, industrial brine, or deicing salts.

The actual detailed mechanism of breakdown of the passive film by chlorides is not known because of the difficulties in examining the process on an atomic scale in the extremely thin passive layers. It is believed that in the thicker films, the chloride ions become incorporated in the film at localized weak spots, creating ionic defects and allowing easy ionic transport. In the case of sub-monolayer passivity, the chloride ions may compete with the hydroxyl ions for locations of high activity on the metal surface, preventing these reactive sites from becoming passivated.

In either case, the net result is that active corrosion can occur at these locations and, once started, it proceeds autocatalytically, that is, in a self-feeding manner. The chloride and ferrous ions react to form a soluble complex that diffuses away from the anodic site. When the complex reaches a region of high pH it breaks down, precipitating an insoluble iron hydroxide and liberating the chloride to remove more iron from the reinforcing steel bar. Moreover, because the region of local breakdown of the passive film becomes anodic,

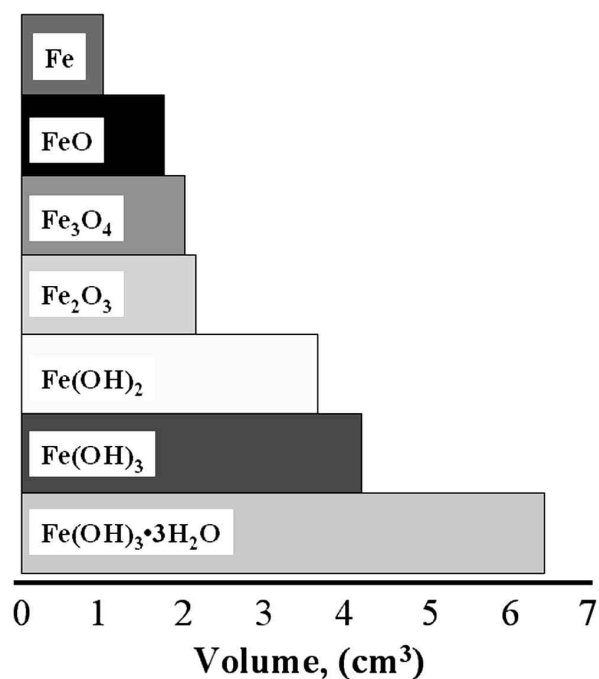

Fig. 2.4—The relative volumes of iron and its reaction product.¹¹

more chloride ions are attracted to that area of the steel than to the surrounding cathodic areas and so the local concentration of chloride ions increased.

The initial precipitated hydroxide has a low state of oxidation and tends to react further with oxygen to form higher oxides. Evidence for this process can be observed when concrete with active corrosion is broken open. A light green semisolid reaction product is often found near the steel which, on exposure to air, turns black and subsequently rust colored. The iron hydroxides have a larger specific volume than the steel from which they were formed, as indicated in Fig. 2.4.¹¹ Consequently, the increases in volume as the reaction products react further with dissolved oxygen leads to an internal stress within the concrete that may be sufficient to cause cracking and spalling of the concrete cover. A second factor in the corrosion process that is often overlooked because of the more dramatic effect of the spalling is the increased acidity in the region of the anodic sites that can lead to local dissolution of the cement paste.

2.2.4.1.a Incorporation of chlorides in concrete during mixing—The use of calcium chloride (CaCl₂) as a set accelerator for concrete has been the most common source of intentionally added chlorides. With the current understanding of the role of chlorides in promoting reinforcement corrosion, however, the use of chloride-containing admixtures is strongly discouraged for reinforced concrete, and for many applications it is not permitted. When chlorides are added to concrete during mixing, intentionally or otherwise, rapid corrosion can occur in the very early stages when the concrete mixture is still plastic, wet, and the alkalinity of the pore solution is not well developed. Once the concrete has begun to harden and the pH has increased, there is normally

*Polarization resistance⁹ (also known as linear polarization) and electrochemical impedance spectroscopy¹⁰ (EIS) measurements can be used to determine the passive corrosion current densities where they are needed for scientific reasons.

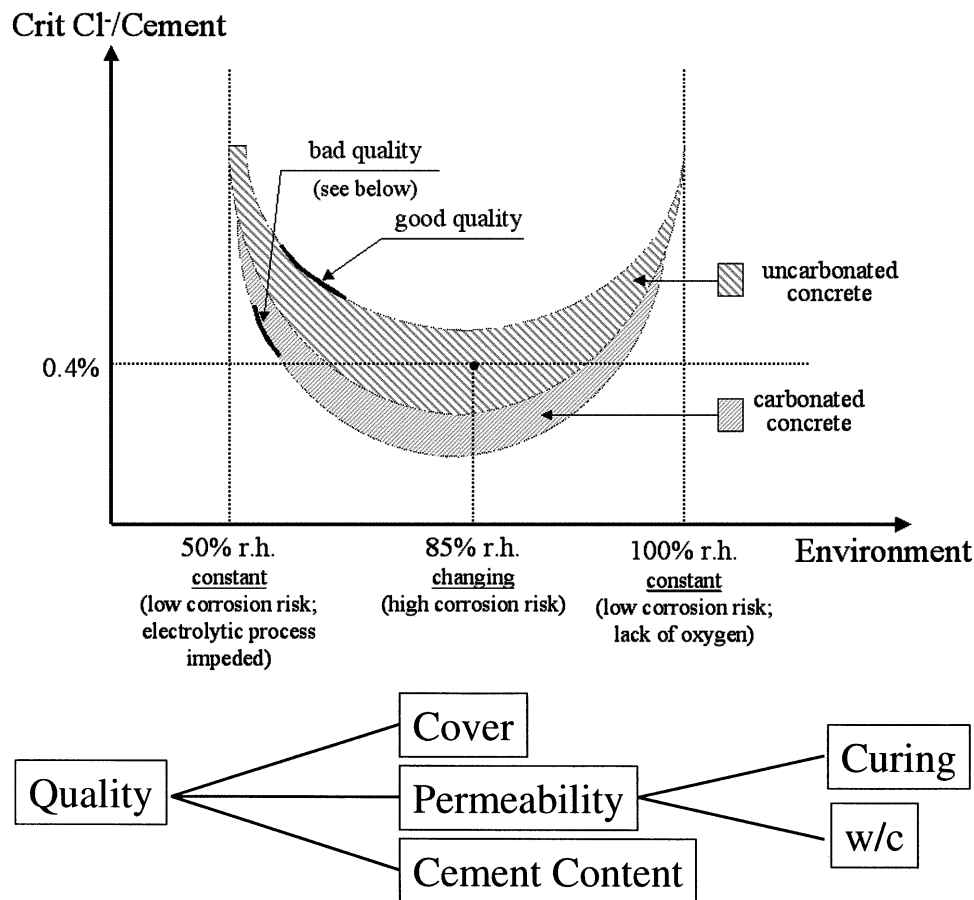

Fig. 2.5—The critical chloride content according to CEB recommendations.²⁵

a decrease in corrosion rate, depending on the concentration of the chlorides.

Chlorides added to the mixture have three additional effects on subsequent corrosion rates. First, it has been shown that the accelerating effect of the chlorides results in a coarser capillary pore-size distribution at a constant water-cement ratio (w/c),¹² which allows faster ingress of additional chlorides, faster carbonation rates, and also reduces the resistivity of the concrete. Second, the chlorides increase the ionic concentration of the pore solution and its electrical conductivity. Both of these factors lead to an increase in the corrosion rate. Third, the chlorides alter the pH of the concrete pore solution; sodium chloride (NaCl) and potassium chloride (KCl) increase the pH whereas CaCl_2 , in high concentrations, reduces the pH.¹³ This affects both the chloride binding and the chloride threshold value for corrosion as described as follows.

2.2.4.1.b Diffusion of chlorides from the environment into mature concrete—Diffusion of chlorides can occur in sound concrete and proceeds through the capillary pore structure of the cement-paste phase. Therefore, cracks in the concrete are not a prerequisite for transporting chlorides to the reinforcing steel. The rate of diffusion depends strongly on a number of factors, including the w/cm , the type of cement,¹⁵ the specific cation associated with the chloride,¹⁶ the temperature,¹⁷ and the maturity of the concrete.¹⁸ Furthermore, there is some indication that penetrating chlorides interact chemically with the cement paste, precipitating

reaction products,¹⁹ thereby decreasing the porosity of the paste phase; that is, they have the opposite effect on porosity from that of intentionally added chlorides.

2.2.4.1.c Chloride binding and threshold values—Not all the chlorides present in the concrete can contribute to the corrosion of the steel. Some of the chlorides react chemically with cement components, such as the calcium aluminates to form calcium chloroaluminates, and are effectively removed from the pore solution. As the concrete carbonates, the chlorides are released and become involved in the corrosion process. Research²⁰ indicates that some chlorides also become physically trapped either by adsorption or in unconnected pores. The fraction of total chlorides available in the pore solution to cause breakdown of the passive film on steel is a function of a number of parameters, including the tricalcium aluminate (C_3A) and tetracalcium aluminoferrite (C_4AF) contents,²¹ pH,²² w/cm ,²³ and whether the chloride was added to the mixture or penetrated into the hardened concrete. The threshold value of chloride concentration below which significant corrosion does not occur is also dependent on several of these same parameters,²⁴ but these factors sometimes work in opposition. For example, the higher the pH, the more chlorides the steel can tolerate without pitting, but the amount of chlorides present in solution for a given total chloride content also increases with pH. Some of these effects are summarized in Fig. 2.5, which shows the effects of relative humidity and quality of the concrete cover on the critical

chloride threshold.²⁵ The threshold value of 0.4% Cl^- by mass of cement proposed by CEB (approximately 1.4 kg/m^3 or 2.4 lb/yd^3 of concrete), however, is higher than the acid-soluble chloride threshold value typically used in the United States, which is 0.6 to 0.9 kg/m^3 (1.0 to 1.5 lb/yd^3) of concrete.

Some researchers have shown that initiation of reinforcing steel corrosion is not only dependent on the chloride-ion concentration, but also on the OH^- concentration and, specifically, the chloride-to-hydroxyl ion ratio (Cl^-/OH^-).²⁵⁻²⁸ The maximum value of Cl^-/OH^- that can be tolerated without breakdown of the passive film has been shown to be 0.29 at pH 12.6 and 0.30 at pH 13.3.^{2,23}

2.2.4.2 Initiation of corrosion by carbonation—Carbonation is the general term given to the neutralization of concrete by reaction between the alkaline components of the cement paste and carbon dioxide (CO_2) in the atmosphere. Because the reaction proceeds in solution, the first indication of carbonation is a decrease in pH of the pore solution to 8.5,²⁹ at which level the passive film on steel is not stable. Carbonation generally proceeds in concrete as a front, beyond which the concrete not affected and the pH is not reduced. When the carbonation front reaches the reinforcing steel, general depassivation^{30,31} over large areas or over the whole steel surface can occur and general corrosion can be initiated.

Fortunately, carbonation rates in sound concrete are generally low. Concrete in or near an industrial area, however, may experience higher carbonation rates due to the increased concentration of CO_2 in industrial environments. Under natural conditions, the atmospheric concentration of CO_2 in air is 0.03%; in cities, this is typically increased to 10 times that value and in industrial sites, it can be as high as 100 times naturally occurring levels.

The ingress of gases is higher at low relative humidities, but the reaction between the gas and the cement paste takes place in solution and is higher at high humidities. Therefore, the most aggressive environment for concrete neutralization will be that of alternate wet and dry cycles and high temperatures.³² Under constant conditions, an ambient relative humidity of 60% has been the most favorable for carbonation.³³ Three other major factors that influence initiation times for carbonation-induced corrosion are: thin concrete cover, the presence of cracks,³⁴ and high porosity associated with a low cement factor and high w/cm .

2.2.4.3 Synergistic effects of carbonation and chlorides—The chloride content at the carbonation front has reached higher levels than in uncarbonated concrete and can be much higher than the levels measured just below the concrete surface.³³ This increases the risk of corrosion initiation when the carbonation front reaches the reinforcing steel. The decrease in pH of the carbonated concrete also increases the risk of corrosion because the concentration of chlorides necessary to initiate corrosion, the threshold value, decreases with the pH.³⁵ This is because the chloroaluminates break down, freeing the bound chlorides as the pH drops.

2.2.5 Corrosion rates after initiation—Depassivation, either local or general, is necessary but not sufficient for active corrosion to occur. The presence of moisture and oxygen are essential for corrosion to proceed at a significant rate.

While the chlorides are directly responsible for the initiation of corrosion, they appear to play only an indirect role in determining the rate of corrosion after initiation. The primary rate-controlling factors are the availability of oxygen, the electrical resistivity, the relative humidity, all of which are interrelated, and the pH and temperature. As mentioned previously, however, the chlorides can influence the pH, electrical conductivity, and the porosity. Similarly, carbonation destroys the passive film but does not influence the rate of corrosion. After corrosion initiation, corrosion rates may also be reduced through the use of a corrosion inhibitor (Section 2.4.5).

Drying of hardened concrete requires transport of water vapor to the surface and subsequent evaporation. Wetting dry concrete occurs by capillary suction and is considerably faster than the drying process.³⁶ Consequently, concrete rarely dries out completely except for a thin layer at the surface.³⁷ Below this surface layer, there will normally be a film of moisture on the walls of the capillaries and the bottlenecks in the pore system will normally be filled. Because the diffusion of dissolved oxygen is approximately four orders of magnitude slower than that of gaseous oxygen,³⁸ diffusion of dissolved oxygen through the bottlenecks will be the rate-controlling process in concrete at normal relative humidities. Laboratory studies³⁹ suggest that there is a threshold value of relative humidity within concrete, in the range of 70 to 85% relative humidity, below which active corrosion cannot take place. Similarly, a high electrical resistivity can inhibit the passage of the corrosion current through the concrete. This is particularly important in the case of macrocell corrosion where there is a significant separation between the anodic and cathodic reaction sites.

Fully submerged concrete structures tend to be protected from corrosion by lack of oxygen. Therefore, despite being contaminated by high concentrations of chlorides, structures continuously submerged below the sea may not be subject to significant corrosion. The part of a structure in the splash zone, however, experiences particularly aggressive conditions. It is generally water-saturated, contains high concentrations of salts, and is sufficiently close to the exposed parts of the structure that macrocells can easily be established. High salt levels arise by salt water being transported by capillary action upward through the concrete cover and evaporation of water from the surface, leaving behind the salts.

2.3—Reinforcing bar

2.3.1 Uncoated bars—Normally, a reinforcing bar is a billet steel made in accordance with ASTM A 615/A 615M or ASTM A 706/A 706M. One problem with the use of uncoated bars is when exposed steel comes in contact with steel embedded in the concrete. This combination acts as a galvanic couple, with the exposed steel becoming anodic and the embedded steel acting as the cathode. In general, the corrosion rate is proportional to the ratio of the cathodic area to the anodic area. Because the amount of embedded steel is often far greater than the exposed steel, the rate of corrosion of the exposed steel can be extremely high.

The currently available alternatives to uncoated bars are epoxy-coated steel or galvanized steel. Stainless steel and

nonmetallic replacements for steel are under consideration but are expensive and not generally available.

2.3.2 Epoxy-coated reinforcing steel—Epoxy-coated reinforcing bars have been widely used in aggressive environments since about 1973 and have generally met with success in delaying corrosion due to the ingress of chlorides. ASTM A 775 and AASHTO⁴⁰ standard specifications were developed that outlined coating application and testing.

Many laboratory and field studies have been conducted on epoxy-coated bars.⁴¹⁻⁴³ To provide long-term corrosion resistance of epoxy-coated steel reinforcement, the coating must have few coating breaks and defects; maintain high electrical resistance; keep corrosion confined to bare areas; resist undercutting; and resist the movement of ions, oxygen, and water. These issues are addressed by ASTM A 775. The standard has the following requirements: 1) the coating thickness should be in the range of 130 to 300 microns; 2) bending of the coated bar around a standard mandrel should not lead to formation of cracks; 3) the number of pinhole defects should be no more than six per meter; and 4) the damage area on the bar should not exceed 2%.

Perhaps the best-known instance of poor field performance of epoxy-coated bars was in several of the rebuilt bridges in the Florida Keys.^{44,45} Florida researchers established that the primary causes of corrosion were inattention to preparation of the bars before coating and debonding of the coating before placement in the structures.

Since 1991, a substantial improvement in the quality of epoxy-coated bars and understanding of adhesion of coatings to steel has developed, primarily as a result of additional research and plant certification programs. In 1992, the Concrete Reinforcing Steel Institute (CRSI) began a program of voluntary certification of plants that apply epoxy coatings to reinforcement.

Considerable research has been conducted on epoxy-coated reinforcing bars over the last 5 years, and field investigations have been conducted by many state agencies. These studies have found that structures containing epoxy-coated bars are more durable than structures with uncoated bars. Laboratory research has shown that new coating products and test methods may improve the long-term durability of concrete structures.⁴⁶ To assess the long-term durability of epoxy coating products, these new test methods should be put in the form of consensus standards.⁴⁷

2.3.3 Galvanized steel—Galvanized steel has been used in concrete for the last 50 years, and is particularly appropriate for protecting concrete subjected to carbonation because zinc remains passivated to much lower levels of pH than does black steel. Unfortunately, zinc dissolves in a high pH solution with the evolution of hydrogen (H_2) as the cathodic reaction. When zinc-coated (galvanized) steel is used in concrete, a porous layer of concrete can form around the reinforcing bar if steps are not taken to prevent it. The performance of galvanized bars significantly decreases if there is carbonation in the concrete surrounding these bars. A small amount of chromate salt may be added to the fresh concrete to prevent hydrogen evolution,⁴⁸ and calcium ni-

trite has been used to prevent hydrogen evolution of galvanized precast concrete forms.

2.3.4 Stainless steel—Stainless steel is under investigation as a reinforcing material for structures in particularly aggressive environments. While ASTM A 304 stainless steel can tolerate higher amounts of chlorides, it is necessary to use the more expensive ASTM A 316L grade to gain significantly improved properties, particularly in bar mats of welded reinforcing steel.⁴⁹

2.4—The concrete environment

2.4.1 Cement and pozzolans—From the viewpoint of corrosion of the reinforcing steel, it is the composition and availability of the pore solution, rather than the concrete itself, that are the controlling factors. Therefore, it is those components of the concrete that determine the pH of the pore solution, the total porosity, and the pore-size distribution that are of importance for the corrosion process.

When portland cement hydrates, the calcium silicates react to form calcium silicate hydrates and calcium hydroxide [$Ca(OH)_2$]. The $Ca(OH)_2$ provides a substantial buffer for the pore solution, maintaining the pH level at 12.6. The pH is generally higher than this value (typically 13.5) because of the presence of potassium and sodium hydroxides (KOH and NaOH), which are considerably more soluble than $Ca(OH)_2$. They are present in limited quantities, however, and any carbonation or pozzolanic reaction rapidly reduces the pH to that of the saturated $Ca(OH)_2$ solution. Thus, from the viewpoint of corrosion, the higher the total alkali content of the cement, the better the corrosion protection. On the other hand, reactive aggregates that may be present in the mixture can lead to expansive and destructive alkali-aggregate reactions.

For a given w/cm , the fineness of the cement and the pozzolanic components determine the porosity and pore-size distribution. In general, mineral admixtures such as fly ash, slag, and silica fume reduce and refine the porosity.⁵⁰ Concretes containing these minerals exhibit considerably enhanced resistance to penetration of chlorides from the environment. If too much pozzolan is used, however, all of the $Ca(OH)_2$ may be used in the pozzolanic reaction, effectively destroying the pH buffer and allowing the pH to drop to levels at which the reinforcing steel is no longer passivated.

Traditionally, the binding capacity of a cement for chloride ions has been considered to be directly related to the C_3A content of the cement. This is because the chloride ions can react to form insoluble chloroaluminates. The chloride ions, however, cannot be totally removed from solution by chemical binding. An equilibrium is always established between the bound and the free chloride ions, so that even with high C_3A contents, there will always be some free chloride ions in solution.

There is increasing evidence that a reaction with C_3A is only one of several mechanisms for effectively removing chloride ions from solution. In ordinary portland cements, there is no direct relationship between the concentration of bound chloride ions and the C_3A content. There is, however, a qualitative relationship with both the ($C_3A + C_4AF$) content and pH of the pore solution.⁵¹ Moreover, chloride binding is enhanced by the presence of fly ash even if the

fly ash does not contain C_3A . The literature contains contradictory results on the effect of silica fume on chloride binding,⁵² but there is general consensus that limited amounts of silica fume are beneficial in providing resistance to chloride-induced corrosion, primarily by reducing the permeability of the concrete. Some adsorption of chlorides on the walls of the pores, or in the interlayer spaces, and some trapping in unconnected pores may account for the higher chloride binding in blended cements with very fine pore structures.⁵³

There has been some controversy concerning the effects of supplementary cementitious materials, particularly fly ash, on carbonation rates. It appears that the decrease in buffer capacity, by the pozzolanic reaction, can allow the neutralization of the cement paste by atmospheric gases to proceed at a higher rate than in ordinary portland cement concretes. This effect is a strong function of the amount and type of fly ash and the curing procedures.

2.4.2 Water-cementitious materials ratio—The porosity and the rate of penetration of deleterious species are directly related to the water-cementitious materials ratio (w/cm). For high-performance concretes, the ratio is generally less than 0.40 and can be as low as 0.30 with the use of suitable water-reducing admixtures. In general, a reduced w/cm results in improved corrosion resistance.

2.4.3 Aggregate—Unless it is porous, contaminated by chlorides, or both, the aggregate generally has little influence on the corrosion of reinforcing steel in concrete. Free moisture on aggregate will contribute to the water content of a concrete mixture and effectively increase the w/cm if it is not accounted for by adjusting the batch water accordingly. The porosity of the paste immediately surrounding the aggregate is usually higher than that of the paste.^{20,50} Therefore, if the size of the aggregate is nearly equivalent to the concrete cover over the reinforcement, the ability of the chloride ions to reach the reinforcement is enhanced. If reactive aggregates are used and alkalis are present in the binder, alkali-silica reactions may take place. This can damage the concrete and potentially accelerate the corrosion process in certain environments.

2.4.4 Curing conditions—The longer concrete is allowed to cure before being exposed to aggressive media, the better it resists penetration by chlorides or CO_2 . This is particularly important for blended cements, especially those containing fly ash, in which the pozzolanic reaction is much slower than the portland cement hydration reactions. At an early age, fly ash concrete usually exhibits lower resistance to penetration of chlorides than an ordinary portland cement concrete, whereas at greater maturity, the fly ash concrete may have superior properties.^{54,55}

2.4.5 Corrosion inhibitors—A corrosion inhibitor for metal in concrete is a substance that reduces the corrosion of the metal without reducing the concentration of the corrosive agent. This is a paraphrase from the ISO definition (ISO 8044-89) of a corrosion inhibitor and is used to distinguish between a corrosion inhibitor and other additions to concrete that improve corrosion resistance by reducing chloride ingress into concrete. Corrosion inhibitors are not a substitute for sound concrete. They can work either as anodic or cathodic

inhibitors, or both, or as oxygen scavengers. A significant reduction in the rate of either anodic or cathodic reactions will result in a significant reduction in the corrosion rate and an increase in the chloride-induced corrosion threshold level. There is a more pronounced effect when an anodic inhibitor is used. Adding an anodic inhibitor promotes the formation of limonite, a hydrous gamma ferric oxide, $\gamma\text{-FeOOH}$, which is a passive oxide at typical concrete pH levels. Adding a cathodic inhibitor or oxygen scavenger stifles the reaction in Eq. (2.2), reducing corrosive oxidation as shown in Eq. (2.1a) and (2.1b).

Numerous chemical admixtures, both organic and inorganic, have been shown to be specific inhibitors of steel corrosion in concrete.⁵⁶⁻⁵⁸ Among the inorganic corrosion inhibitors are potassium dichromate, stannous chloride, sodium molybdate, zinc and lead chromates, calcium hypophosphite, sodium nitrite, and calcium nitrite. Sodium nitrite has been used with apparent effectiveness in Europe.⁵⁹ Calcium nitrite is the most widely used inorganic corrosion inhibitor in concrete,^{60,61} and it has the advantage of not having the side effects of sodium nitrite, namely low compressive strength, erratic setting times, efflorescence, and enhanced susceptibility to alkali-silica reaction. Organic inhibitors suggested have included sodium benzoate, ethyl aniline, morpholine, amines, and mercaptobenzothiazole.

As in the case of other admixtures, corrosion inhibitors might affect plastic and hardened concrete properties. Before using them, their effects on concrete properties should be understood and, where necessary, appropriate steps should be taken in consultation with the inhibitor manufacturer to overcome or minimize detrimental interactions. Since corrosion-inhibiting admixtures are water soluble, there is concern that leaching from the concrete can occur, particularly of inorganic salts, effectively reducing the concentration of the inhibitor at the level of the reinforcement. When used in sound concrete with w/cms less than or equal to 0.4 and adequate concrete covers, the effects of leaching are significantly reduced.⁶²

CHAPTER 3—PROTECTION AGAINST CORROSION IN NEW CONSTRUCTION

3.1—Introduction

Measures that can be taken in reinforced concrete construction to protect reinforcing steel against corrosion can be divided into three categories:

1. Design and construction practices that maximize the protection afforded by the portland cement concrete;
2. Treatments that penetrate, or are applied on the surface of, the reinforced concrete member to prevent the entry of chloride ion into the concrete; and
3. Techniques that prevent corrosion of the steel reinforcement directly.

In category 3, two approaches are possible—to use corrosion-resistant reinforcing steel or to nullify the effects of chloride ions on unprotected reinforcement.

3.2—Design and construction practices

Through careful design and good construction practices, the protection provided by portland cement concrete to embedded reinforcing steel can be optimized. It is not the technical sophistication of the structural design that determines the durability of a reinforced concrete member in a corrosive environment, but the detailing.⁶³ The provision of adequate drainage and a method of removing drainage water from the structure are particularly important. In reinforced concrete structural members exposed to chlorides and subjected to intermittent wetting, the degree of protection against corrosion is determined primarily by the depth of concrete cover to the reinforcing steel and the permeability of the concrete.⁶⁴⁻⁶⁹ Estimates of the increase in corrosion protection provided by an increase in concrete cover have ranged between slightly more than a linear relationship^{65,70} to as much as the square of the cover.⁷¹

Corrosion protection of cover concrete is a function of both depth of concrete cover and w/cm .⁶⁹ A concrete cover of 25 mm (1 in.) was inadequate, even with a w/cm as low as 0.28. Adding silica fume, however, made the 25 mm (1 in.) concrete cover effective. The time to spalling after the initiation of corrosion is a function of the ratio of concrete cover to bar diameter,⁷¹ the reinforcement spacing, and the concrete strength. Although conventional portland cement concrete is not impermeable, concrete with low permeability can be made through the use of appropriate materials, including admixtures, a low w/cm , good consolidation and finishing practices, and proper curing.

In concrete that is continuously submerged, the rate of corrosion is controlled by the rate of oxygen diffusion, which is not significantly affected by the concrete quality or the thickness of concrete cover.⁷² As mentioned in [Chapter 2](#), however, corrosion of embedded reinforcing steel is rare in continuously submerged concrete structures. In seawater, the permeability of the concrete to chloride penetration is reduced by the precipitation of magnesium hydroxide.⁷³

Limits on the allowable amounts of chloride ion in concrete is an issue still under active debate. On the one side are the purists who would like to see essentially no chlorides in concrete. On the other are the practitioners, including those who must produce concrete under cold-weather conditions, precast-concrete manufacturers who wish to minimize curing times, producers of chloride-bearing aggregates, and some admixture companies, who would prefer the least restrictive limit possible. A zero-chloride content limit for any of the mixture ingredients is unrealistic, because trace amounts of chlorides are present naturally in most concrete-making materials.⁷⁴ The risk of corrosion, however, increases as the chloride content increases. When the chloride content exceeds a certain value, termed the chloride-corrosion threshold, corrosion can occur provided that oxygen and moisture exist to support the corrosion reactions. It is impossible to establish a single chloride content below which the risk of corrosion is negligible for all mixture ingredients and under all exposure conditions, and that can be measured by a standard test.

The chloride content of concrete is expressed as water-soluble, acid-soluble, which includes water-soluble and acid-insoluble chlorides, depending on the analysis method used. Special analytical methods are necessary to determine the total chloride content. Three different analytical methods have been used to determine the chloride content of fresh concrete, hardened concrete, or any of the concrete mixture ingredients. These methods determine total chloride, acid-soluble chloride, and water-soluble chloride. Acid-soluble chloride is often, but not necessarily, equal to total chloride. The acid-soluble method measures chloride that is soluble in nitric acid. The water-soluble chloride method measures chloride extractable in water under defined conditions. The result obtained varies with the analytical test procedure, particularly with respect to particle size, extraction time, temperature, and the age and environmental exposure of the concrete.

It is important to clearly distinguish between chloride content, sodium chloride content, calcium chloride content, or any other chloride salt content. In this report, all references to chloride content pertain to the amount of acid-soluble chloride ion (Cl^-) present. Chloride contents for concrete or mortar are expressed in terms of the mass of cement, unless stated otherwise, and must be calculated from analytical data that measure chloride as a percent by mass of the analyzed sample.

Lewis⁷⁵ reported that, on the basis of polarization tests of steel in saturated calcium hydroxide solution and water extracts of hydrated cement samples, corrosion occurred when the chloride content was 0.33% acid-soluble chloride or 0.16% water-soluble chloride based on a 2-h extraction in water. The porewater in many typical portland cement concretes, made using relatively high-alkali cements, is a strong solution of sodium and potassium hydroxides with a pH approaching 14, well above the 12.4 value for saturated calcium hydroxide. Because the passivity of embedded steel is determined by the ratio of the hydroxyl concentration to the chloride concentration,⁷⁶ the amounts of chloride that can be tolerated in concrete are higher than those that will cause pitting corrosion in a saturated solution of calcium hydroxide.⁷⁷

Work at the Federal Highway Administration (FHWA) laboratories⁶⁷ showed that for hardened concrete subject to externally applied chlorides, the corrosion threshold was 0.20% acid-soluble chlorides. A later study,⁶⁹ sponsored by FHWA at another laboratory, found the threshold to be 0.21% by mass of cement, which is in excellent agreement. The average content of water-soluble chloride in concrete was found to be 75 to 80% of the acid-soluble chloride content in the same concrete. This corrosion threshold value was subsequently confirmed by field studies of bridge decks, including several in California⁷⁸ and New York,⁷⁹ which showed that under some conditions a water-soluble chloride content of as little as 0.15%, or 0.20% acid-soluble chloride, is sufficient to initiate corrosion of embedded mild steel in concrete exposed to chlorides in service. The FHWA-sponsored study,⁶⁹ however, found that for an unstressed prestressing strand, the chloride threshold was 1.2% by mass of cement, nearly six times that of nonprestressing reinforcing steel. When stressed, the strand was more susceptible to corrosion, but was still more resistant than mild steel. The authors later

found that commercially available strand wires are coated with zinc phosphate, calcium stearate, and other lubricants before drawing. These coatings may provide corrosion protection to the strands.

In determining a limit on the chloride content of the mixture ingredients, several other factors need to be considered. As noted in the values already given, the water-soluble chloride content is not a constant fraction of the acid-soluble chloride content. It varies with the amount of chloride in the concrete,⁷⁵ the mixture ingredients, and the test method. All the materials used in concrete contain some chlorides, and the water-soluble chloride content in the hardened concrete varies with cement composition, as discussed previously. Although aggregates do not usually contain significant amounts of chloride,⁷⁴ there are exceptions. There are reports of aggregates with an acid-soluble chloride content of more than 0.1%, of which less than one-third is water-soluble, even when the aggregate is pulverized.⁸⁰ The chloride is not soluble when the unpulverized aggregate is placed in water over an extended period, and there is no difference in the corrosion performance of reinforced concrete structures in southern Ontario made from this aggregate compared with that of other chloride-free aggregates in that region.

The Ontario aggregate is not duplicated with most other aggregates. Some aggregates, particularly those from arid areas or dredged from the sea, can contribute sufficient chlorides to the concrete to initiate corrosion.

The chloride-corrosion threshold value may depend on whether the chloride is present in the mixture ingredients or penetrates the hardened concrete from external sources. When chlorides are added to the mixture, some will chemically combine with the hydrating cement paste, predominantly the aluminate phase. The amount of chloride that forms calcium chloroaluminates is a function of the C_3A content of the cement.⁸¹ Chlorides added to the mixture also tend to be distributed relatively uniformly and, therefore, do not have a tendency to create concentration cells.

Conversely, when chlorides permeate from the surface of hardened concrete, uniform chloride contents will not exist around the reinforcing steel because of differences in the concentration of chlorides on the concrete surface, local differences in permeability, and variations in the depth of concrete cover to the reinforcing steel, including the spacing between the top and bottom mats. All these factors promote differences in the oxygen, moisture, and chloride-ion contents in the environment surrounding a given piece of steel reinforcement. Furthermore, most reinforced concrete structural members contain steel reinforcement at different depths that usually get connected electrically because the procedures used to position and secure the reinforcing steel, such as the use of bent bars, chairs, or tie wires, permit metal-to-metal contact. Therefore, when chlorides penetrate the concrete, some of the reinforcing steel is in contact with chloride-contaminated concrete, while other reinforcing steel is in relatively chloride-free concrete. The difference in chloride concentrations within the concrete creates a macroscopic corrosion cell that can possess a large driving voltage and a large cathode-to-anode ratio that accelerates the rate of corrosion.

Table 3.1—Chloride limits for new construction

Category	Chloride limit for new construction (% by mass of cement)		
	Test method		
	Acid-soluble	Water-soluble	
	ASTM C 1152	ASTM C 1218	Soxhlet*
Prestressed concrete	0.08	0.06	0.06
Reinforced concrete in wet conditions	0.10	0.08	0.08
Reinforced concrete in dry conditions	0.20	0.15	0.15

*The Soxhlet test method is described in ACI 222.1.

In laboratory studies⁸² where sodium chloride was added to the mixture ingredients, a substantial increase in corrosion rate occurred between 0.4 and 0.8% chloride by mass of cement, although the moisture conditions of the test specimens were not clearly defined. Other researchers have suggested⁸³ that the critical level of chlorides in the mixture ingredients to initiate corrosion is 0.3%, and that this value has an effect similar to 0.4% chlorides penetrating the hardened concrete from external sources. In studies where calcium chloride was added to portland cement concrete, the chloride-ion concentration in the pore solution remained high during the first day of hydration.⁸⁴ Although it gradually declined, a substantial concentration of chloride-ion remained in solution indefinitely.

Chloride limits in national building codes vary widely. ACI 318-95 allows a maximum water-soluble chloride-ion content by mass of cement of 0.06% in prestressed concrete, 0.15% for reinforced concrete exposed to chlorides in service, 1.00% for reinforced concrete that will be dry or protected from moisture in service, and 0.30% for all other reinforced concrete construction. The British Code, CP 110, allows an acid-soluble chloride-ion content of 0.35% for 95% of the test results with no result greater than 0.50%. These values are largely based on an examination of several structures that had a low risk of corrosion with up to 0.4% chlorides added to the mixture.⁸⁵ Corrosion has occurred at values less than 0.4%,^{69,86,87} particularly where the chloride content was not uniform. The Norwegian Code, NS 3420-L, allows an acid-soluble chloride content of 0.6% for reinforced concrete made with normal portland cement, but only 0.002% chloride ion for prestressed concrete. Other codes have different limits, though their rationale is not well established.

Corrosion of prestressing steel is generally a greater concern than corrosion of nonprestressed reinforcement because of the possibility that corrosion may cause a local reduction in cross section and failure of the prestressing steel. The high stresses in the prestressing steel also render it more vulnerable to stress-corrosion cracking and, where the loading is cyclic, to corrosion fatigue. Most reported examples of failure of prestressing steel^{85,88,89} have resulted from macrocell corrosion reducing the load-carrying area of the steel. Because of the potentially greater vulnerability and the consequences of corrosion of prestressing steel, chloride limits for prestressed concrete are lower than those for reinforced concrete.

Based on the present state of knowledge, the chloride limits in Table 3.1 for concrete used in new construction, expressed

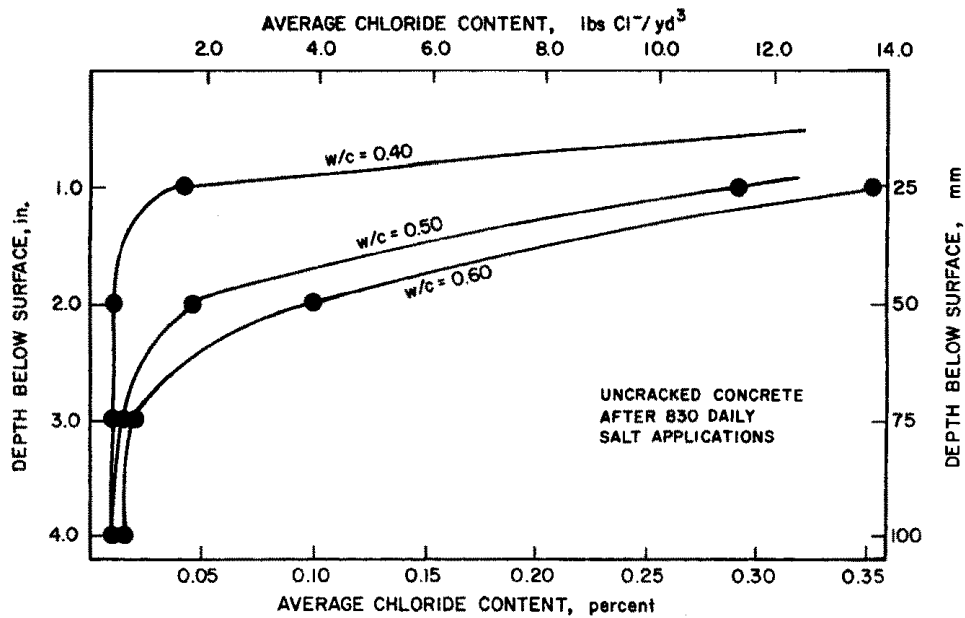

Fig. 3.1—Effect of water-cement ratio on salt penetration.²⁴

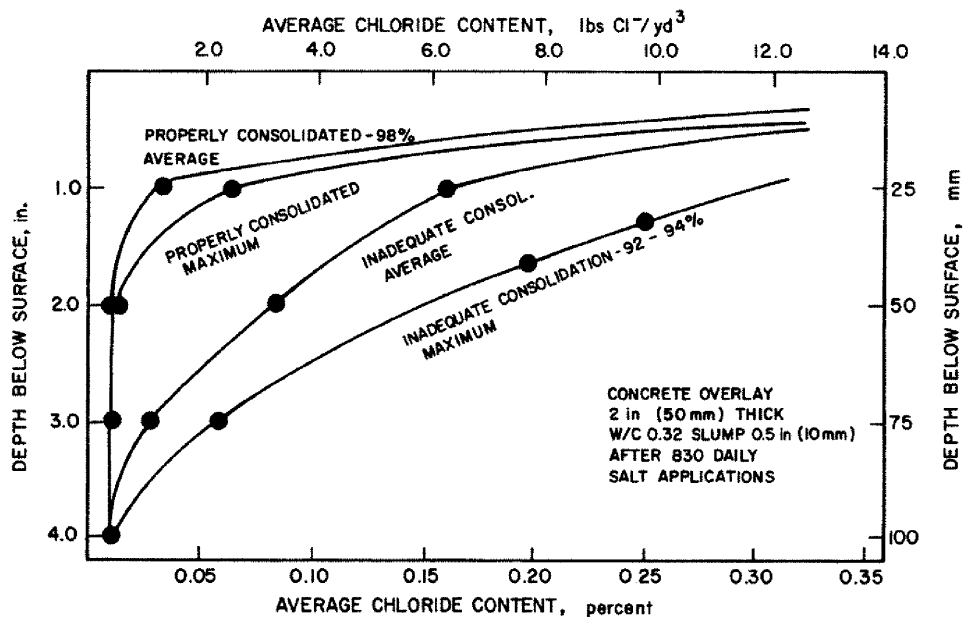

Fig. 3.2—Effect of inadequate consolidation on salt penetration.²⁴

as a percentage by mass of portland cement, are recommended to minimize the risk of chloride-induced corrosion.

The committee emphasizes that these are recommended limits for new construction and not thresholds for electrochemical corrosion.

Normally, concrete materials are tested for chloride content using either the acid-soluble test described in ASTM C 1152 or the water-soluble test described in ASTM C 1218. If the concrete materials meet the requirements given in either of the relevant columns in Table 3.1, they should be acceptable. If the concrete materials do not meet the relevant limits given in the table, then they may be tested using the Soxhlet Test Method. Some aggregates contain a considerable

amount of chloride that is sufficiently bound and does not initiate or contribute towards corrosion. The Soxhlet test appears to measure only those chlorides that contribute to the corrosion process,⁹⁰ thus permitting the use of some aggregates that would not be allowed if only the ASTM C 1152 or ASTM C 1218 tests were used. If the concrete materials fail the Soxhlet test, then they are not suitable.

For prestressed and reinforced concrete exposed to chlorides in service, it is advisable to maintain the lowest possible chloride levels in the concrete mixture to maximize the service life of the concrete before the critical chloride content is reached and a high risk of corrosion develops. Consequently, chlorides should not be intentionally added to the mixture in-

gradients even if the chloride content in the materials is less than the stated limits. In many exposure conditions, such as highway and parking structures, marine environments, and industrial plants where chlorides are present, additional protection against corrosion of embedded reinforcing steel is necessary.

Because moisture and oxygen are always necessary for electrochemical corrosion, there are some exposure conditions where corrosion will not occur even though the chloride levels may exceed the recommended values. For example, reinforced concrete that is continuously submerged in seawater rarely exhibits corrosion-induced distress because insufficient oxygen is present. If a portion of a reinforced concrete member is above and a portion below water level, the portion above can promote significant corrosion of the lower portion due to an oxygen-concentration cell. Similarly, where concrete is continuously dry, such as the interior of a building, there is little risk of corrosion from chloride ions present in the hardened concrete. Interior locations that are wetted occasionally, such as kitchens and laundry rooms, or buildings constructed with pumped lightweight concrete that is subsequently sealed before the concrete dries out, for example with vinyl tiles, are susceptible to corrosion damage. The designer has little control over the change in use or the service environment of a building, but the chloride content of the concrete mixture ingredients can be controlled. Estimates of whether a particular environment will be dry can be misleading. Stratfull⁹¹ has reported case studies of approximately 20 bridge decks containing 2% calcium chloride built by the California Department of Transportation. The bridges were located in an arid area where the annual rainfall was about 125 mm (5 in.), most of which fell during a short period of time. Within 5 years of construction, many of the bridge decks were showing signs of corrosion-induced spalling, and most were removed from service within 10 years. For these reasons, a conservative approach is necessary.

The maximum chloride limits recommended in Table 3.1 for reinforced concrete differ from those published in ACI 318-95. As noted previously, Committee 222 has taken a more conservative approach because of the serious consequences of corrosion, the conflicting data on corrosion-threshold values, and the difficulty of defining the service environment throughout the life of a structure. Potentially, some or all of the water-insoluble chloride in concrete, like that combined with C_3A , may become water-soluble at a later age due to reactions with carbonate or sulfate that displace or release the chloride in the insoluble compound of the concrete and free it into the pore water.

Various nonferrous metals and alloys will corrode in damp or wet concrete. Surface attack of aluminum occurs in the presence of alkali-hydroxide solutions, which are always present to some degree in concrete. Anodizing provides no protection.

Much more serious corrosion can occur if the concrete contains chloride ions, particularly if there is electrical (metal-to-metal) contact between the aluminum and steel reinforcement because a galvanic cell is created. Serious

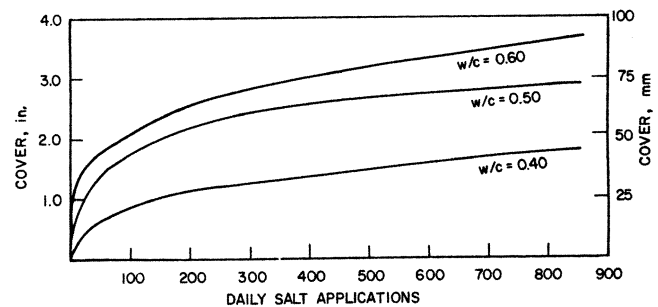

Fig. 3.3—Effect of water-cement ratio and depth of concrete cover on relative time to corrosion.²⁴

cracking or spalling of concrete over aluminum conduits has been reported.^{92,93} Certain organic protective coatings have been recommended⁹⁴ where aluminum must be used and where it is impractical to avoid contamination by chlorides. Other metals, such as zinc, nickel, and cadmium, which have been evaluated for use as coatings for reinforcing steel, are discussed elsewhere in this chapter. Additional information is contained in Reference 95.

Where concrete will be exposed to chlorides, the concrete should be made with the lowest w/c consistent with achieving adequate consolidation. The effects of w/c and degree of consolidation on the rate of ingress of chloride ions are shown in Fig. 3.1 and 3.2. Concrete with a w/c of 0.40 was found to resist penetration by deicing salts significantly better than concretes with w/c s of 0.50 and 0.60. A low w/c is not, however, sufficient to ensure low permeability. As shown in Fig. 3.2, concrete with a w/c of 0.32 but with poor consolidation is less resistant to chloride-ion penetration compared with good consolidated concrete with a w/c of 0.60. The combined effect of w/c and depth of concrete cover is shown in Fig. 3.3, which illustrates the number of daily applications of salt before the chloride content reached the critical value (0.20% acid soluble) at the various depths. Thus, 40 mm (1.5 in.) of 0.40 w/c concrete was sufficient to protect embedded reinforcing steel against corrosion for 800 salt applications. Equivalent protection was provided by 70 mm (2.75 in.) of concrete cover with a w/c of 0.50, or 90 mm (3.5 in.) of 0.60 w/c concrete. On the basis of this work, ACI 201.2R recommends a minimum of 50 mm (2 in.) concrete cover for the top steel in bridge decks if the w/c is 0.40 and 65 mm (2.5 in.) if the w/c is 0.45. Even greater cover, or the provision of additional corrosion protection treatments, may be required in some environments. These recommendations can also be applied to other reinforced concrete structural components similarly exposed to chloride ions and intermittent wetting and drying.

Even when the recommended cover is specified, construction practices should ensure that the specified concrete cover is achieved. Placing tolerances for reinforcing steel, the method of construction, and the level of inspection should be considered in assuring that the specified concrete cover is achieved.

The role of cracks in the corrosion of reinforcing steel is controversial. Two viewpoints exist.^{96,97} One viewpoint is that cracks reduce the service life of reinforced concrete structures by permitting deeper and rapid penetration of car-

bonation and a means of access of chloride ions, moisture, and oxygen to the reinforcing steel. The cracks accelerate the onset of the corrosion processes, and at the same time, provide space for the deposition of the corrosion products. The other viewpoint is that while cracks may accelerate the onset of corrosion, such corrosion is localized. Because the chloride ions eventually penetrate uncracked concrete and initiate more widespread corrosion of the reinforcing steel, the result is that after a few years in service there is little difference between the amount of corrosion in cracked and uncracked concrete.

The differing viewpoints can be partly explained by the fact that the effect of cracks is a function of their origin, width, depth, spacing, and orientation. Where the crack is perpendicular to the reinforcement, the corroded length of intercepted reinforcing bars is likely to be no more than three bar diameters.⁹⁷ Cracks that follow the line of a reinforcing bar (as might be the case with a settlement crack) are much more damaging because the corroded length of the bar is greater and the resistance of the concrete to spalling is reduced. Studies have shown that cracks less than approximately 0.3 mm (0.012 in.) wide have little influence on the corrosion of reinforcing steel.⁷¹ Other investigations have shown that there is no relationship between crack width and corrosion;⁹⁸⁻¹⁰⁰ however, one study¹⁰² showed that closely spaced cracks can actually cause greater corrosion rates with more widely spaced, wider cracks. Furthermore, there is no direct relationship between surface crack width and the internal crack width. Consequently, it has been suggested that control of surface crack widths in building codes is not the most rational approach from a durability viewpoint.¹⁰² A detailed discussion relating to cracking is available in ACI 224R.

For the purposes of design, it is useful to differentiate between controlled and uncontrolled cracks. Controlled cracks can be reasonably predicted from knowledge of section geometry and loading and are generally narrow. For cracking perpendicular to the main reinforcement, the necessary conditions for crack control are sufficient reinforcing steel so that it remains elastic under all loading conditions and the steel should be bonded at the time of cracking, that is, cracking must occur after the concrete has attained sufficient strength.

Uncontrolled cracks are often wide and usually cause concern, particularly if they are active. Examples of uncontrolled cracking are cracks resulting from plastic shrinkage, settlement, or an overload condition. Measures should be taken to avoid their occurrence, or if they are unavoidable, to induce them at places where they are unimportant or can be conveniently dealt with, for example, by sealing.

3.3—Methods of excluding external sources of chloride ion from concrete

3.3.1 Waterproof membranes—Waterproof membranes have been used to minimize the ingress of chloride ions into concrete. A barrier to water will also act as a barrier to any externally derived dissolved chlorides. Some membranes offer substantial resistance to chloride and moisture intrusion, even when pinholes, bubbles, or preformed cracks are present. To measure the resistance of a membrane to an hy-

drostatic head over a preformed crack in concrete, the membrane should be tested in accordance with ASTM D 5385.

The requirements for the ideal waterproofing system are straightforward:¹⁰³

- Be easy to install;
- Have good bond to the substrate;
- Be compatible with all the components of the system including the substrate, prime coat, adhesives, and overlay (where used); and
- Maintain impermeability to chlorides and moisture under service conditions, especially temperature extremes, crack movements, aging, and superimposed loads.

The number of types of products manufactured that satisfy these requirements makes generalization difficult, though one of the most useful is the distinction between the preformed sheet systems and the liquid-applied materials.¹⁰³ The preformed sheets are formed under factory conditions but are often difficult to install, usually requiring adhesives, and are highly vulnerable to the quality of the workmanship at critical locations in the installation, such as at slab penetrations. Although it is more difficult to control the quality of the workmanship with the liquid-applied systems, they are easier to apply and tend to be less expensive.

Given the different types and quality of available waterproofing products, the differing degrees of workmanship, and the wide variety of applications, it is not surprising that laboratory¹⁰⁴⁻¹⁰⁶ and field^{79,107,108} evaluations of membrane performance have also been variable and sometimes contradictory. Sheet systems generally perform better than liquid-applied systems in laboratory screening tests because workmanship is not a factor. Although there has been little uniformity in methods of test or acceptance criteria, permeability, usually determined by electrical-resistance measurements, has generally been adopted as the most important criterion. Some membranes, however, offer substantial resistance to chloride and moisture intrusion even when pinholes or bubbles are present.¹⁰⁶

Field performance depends not only on the type of waterproofing material used, but also on the workmanship, weather conditions, design details, and the service environment. Experience has ranged from satisfactory¹⁰⁸ to failures that have resulted in the membrane having to be removed.^{109,110}

Blistering, which affects both preformed sheets and liquid-applied materials, is the single greatest problem encountered in applying waterproofing membranes.¹¹¹ It is caused by the expansion of entrapped gases, solvents, or moisture in the concrete after application of the membrane. The frequency of blistering is controlled by the porosity and moisture content of the concrete¹¹² and by atmospheric conditions. Water or water vapor is not necessary for blistering, but is often a contributing factor. Blisters may result from an increase in concrete temperature or a decrease in atmospheric pressure during or shortly after membrane application. The rapid expansion of vapors during the application of hot-applied products sometimes causes punctures, termed blowholes, in the membrane.

Membranes can be installed without blistering if the atmospheric conditions are suitable during the curing period.

Once cured, the adhesion of the membrane to the concrete is usually sufficient to resist blister formation. To ensure good adhesion, the concrete surface should be carefully prepared, dried, and free from curing membranes, laitance, and contaminants such as oil drippings. Sealing the concrete before applying the membrane is possible but rarely practical.¹¹³ Where the membrane is to be covered, for example, with insulation or a protective layer, the risk of blister formation can be reduced by minimizing the time between placing the membrane and the overlay.

Venting layers have been used in Europe to prevent blister formation by allowing the vapor pressures to disperse beneath the membrane. The disadvantages of using venting layers are that they require controlled debonding of the membrane, leakage through the membrane is not confined to the immediate area of a puncture, and they increase cost. Vent tubes oriented away from exposed surfaces have also been used.

3.3.2 Polymer impregnation—Polymer impregnation consists of filling some of the voids in hardened concrete with a monomer and polymerizing in place. Laboratory studies have demonstrated that polymer-impregnated concrete (PIC) is strong, durable, and almost impermeable.¹¹⁴ The properties of PIC are largely determined by the polymer loading in the concrete. Maximum polymer loadings are achieved by drying the concrete to remove nearly all the evaporable water, removing air by vacuum techniques, saturating with a monomer under pressure, and polymerizing the monomer while simultaneously preventing evaporation of the monomer. The need for severe drying and the subsequent cracking in full-scale applications, plus the high cost, have prevented this technique from becoming a practical solution to chloride ingress.¹¹⁵ Additional information on PIC is given in ACI 548.1R.

There have been a few full-scale applications of PIC to protect reinforcing steel against corrosion, but it is still largely experimental. Some of the disadvantages of PIC are that the monomers are expensive and that the processing is lengthy and costly.¹¹⁶ The principal deficiency identified has been the tendency of the concrete to crack during heat treatment.

3.3.3 Polymer concrete overlays—Polymer concrete overlays consist of aggregate in a polymer binder. The polymer binders commonly used are polyesters, acrylics, and epoxies. Polymer overlays can be placed either by spreading the resin over the concrete deck and broadcasting the aggregate into the resin,¹¹⁷ or by premixing all the ingredients and placing the polymer concrete with a screed. Polymer concretes are rapid setting, can be formulated for a wide variety of strengths and flexibility, are highly abrasion-resistant, and are resistant to water and chloride-ion penetration. They are placed between 5 to 40 mm (1/4 to 1-1/2 in.) thick. High shrinkage and high coefficients of thermal expansion make some resins incompatible with concrete decks; therefore, careful selection of the polymer binder and aggregate gradation is required. Additional information on polymer concrete is given in ACI 548.5R.

Most monomers have a low tolerance to moisture and low temperatures when applied; therefore, the substrate should be dry and in excess of 4 C (40 F). Improper mixing of the two

(or more) components of the polymer has been a common source of problems in the field. The concrete substrate and aggregates should be dry so as not to inhibit the polymerization.

A bond coat of neat polymer is usually applied ahead of the polymer concrete. Blistering, a common phenomenon in membranes, has also caused problems in the application of polymer concrete overlays. A number of applications were reported in the 1960s.^{118,119} Many lasted only a few years. More recently, experimental polymer overlays based on a polyester-styrene monomer have been placed using heavy-duty finishing equipment to compact and finish the concrete.^{120,121}

Workers should wear protective clothing when working with many polymers because of the potential for skin sensitization and dermatitis.¹²² Manufacturers' recommendations for safe storage and handling of the chemicals should be followed.

3.3.4. Portland cement concrete overlays—Portland cement concrete overlays for new reinforced concrete are applied as part of two-stage construction. The overlay may be placed before the first-stage concrete has set, or several days later, in which case a bonding layer is used between the two lifts of concrete. The advantage of the first alternative is that the overall time of construction is shortened, extensive preparation of the substrate is not required, and costs are minimized. In the second alternative, concrete cover to the reinforcing steel can be ensured and small construction tolerances achieved because dead-load deflections from the overlay are very small. No matter which sequence of construction is used, materials are incorporated in the overlay to provide superior properties, such as improved resistance to salt penetration and wear and skid resistance.

Where the second-stage concrete is placed after the first stage has hardened, sand, steel shot, or water blasting is required to remove laitance and to produce a clean, rough, and sound surface. Resin curing compounds should not be used on the first-stage construction because they will prevent bonding and are difficult to remove. Etching with acid was once a common means of surface preparation,^{123,124} but is now rarely used because of the possibility of contaminating the concrete with chlorides and the difficulty of disposing of the runoff. It also weakens the surface, whereas mechanical preparation removes any soft surficial material.

Several different types of concrete have been used as concrete overlays, including conventional concrete,¹²⁵ concrete containing steel fibers,¹²⁵ and internally sealed concrete.^{125,126} Two types of concrete, silica fume-modified and latex-modified concrete—each designed to offer maximum resistance to penetration by chloride ions—have been used most frequently.

3.3.5 Silica fume-modified concrete overlays—The performance of this type of concrete is superior to that of the previously used low-slump concrete and is much easier to consolidate and finish. Using silica fume and a high-range water-reducer, low permeability to chloride intrusion can be obtained. Only moderate cement contents are needed to produce a *w/cm* well below 0.40 due to the ability of the high-range water reducer to greatly reduce concrete water requirements. The concrete should be air-entrained if used outdoors.

Following preparation of the first-stage concrete, either mortar or cement paste slurry, typically supplied in truck mixers, is usually brushed into the base concrete just before the application of the overlay concrete. The base concrete is not normally prewetted. It is sometimes specified that mortar from the overlay concrete be worked into the surface using stiff-bristle brooms instead of using a separate bond coat.

Curing is performed the same as conventional concrete. Because of greatly reduced bleeding, the potential for plastic shrinkage cracking is increased. Therefore, early and proper curing is especially important.

3.3.6 Latex-modified concrete overlays—Latex-modified concrete is conventional portland cement concrete with the addition of a polymeric latex. The latex is a colloidal dispersion of polymer particles in water. The particles are stabilized to prevent coagulation, and antifoaming agents are added to prevent excessive air entrapment during mixing. The water of dispersion in the latex helps to hydrate the cement, and the polymer provides supplementary binding properties to produce concrete with a low w/cm , good durability, good bonding characteristics, and a high degree of resistance to penetration by chloride ions. All of these are desirable properties of a concrete overlay.

Styrene-butadiene latexes have been used most widely, although acrylic formulations are becoming more popular. The rate of adding the latex is approximately 15% latex solids by mass of the cement.

The construction procedures for latex-modified concrete are similar to those for silica fume-modified concrete with minor modifications. The principal differences are:

- The base concrete should be prewetted for at least 1 h before placing the overlay because the water aids penetration of the base and delays film formation of the latex;
- The mixing equipment should have a means of storing and dispensing the latex;
- An air-entraining admixture is not required for resistance to freezing and thawing; and
- A combination of initial moist curing for some hydration of the portland cement and air drying to cause coalescence of the latex are required. Typical curing times are 24 to 72 h wet curing, followed by at least 72 h of dry curing. Coalescence of the latex is temperature-sensitive, and strengths develop slowly at temperatures below 13 C (55 F). Curing periods at lower temperatures may need to be extended, and application at temperatures less than 7 C (45 F) is not recommended.

Hot weather causes rapid drying of the latex-modified concrete, which makes finishing difficult. Similar to silica fume, the latex reduces bleeding and promotes plastic shrinkage cracking. Some contractors have placed overlays at night to avoid these problems. The entrapment of excessive amounts of air during mixing has also been a problem in the field. Most project specifications limit the total air content to 6.5%. Higher air contents reduce the flexural, compressive, and bond strengths of the overlay.

Where a texture is applied to the concrete, such as grooves to impart skid resistance, the time of application of the texture is crucial. If applied too soon, the edges of the grooves

collapse because the concrete flows. If the texturing operation is delayed until after the latex film forms, the surface of the overlay tears, and because the film does not reform, cracking often results.

High material prices and the superior performance of latex-modified concrete in chloride penetration tests have led to latex-modified concrete overlays being thinner than most low-slump concrete overlays. Typical thicknesses are 40 to 50 mm (1.5 to 2 in.).

Although latex-modified overlays were first used in 1957,¹²⁷ the majority of installations have been placed since 1975. Performance has been satisfactory, though extensive cracking and some debonding have been reported,¹²⁸ especially in overlays 20 mm (0.75 in.) thick that were not applied at the time of the original deck construction. The most serious deficiency reported has been the widespread occurrence of plastic-shrinkage cracking in the overlays. Many of these cracks have been found not to extend through the overlay and they apparently do not impair long-term performance. Additional information on latex-modified concrete is given in ACI 548.3R, and ACI 548.4R presents a guide specification for its use.

3.4—Corrosion control methods

The susceptibility to corrosion of nonprestressed steel reinforcement is not significantly affected by its chemical composition, tensile properties, or level of stress.¹²⁹ Consequently, to prevent corrosion of the reinforcing steel in a corrosive environment, either the reinforcement should be made of a noncorrosive material or nonprestressed reinforcing steel should be coated to isolate the steel from contact with oxygen, moisture, and chlorides. Corrosion of the reinforcement may also be mitigated through the use of corrosion inhibitors or the application of cathodic protection.

3.4.1 Noncorrosive steels—Weathering steels commonly used for structural steel construction do not perform well in concrete containing moisture and chlorides⁶⁴ and are not suitable for reinforcement. Stainless steel reinforcement has been used in special applications, especially as hardware for attaching panels in precast concrete construction, but presently, relatively high material costs preclude it from replacing nonprestressed steel reinforcement in most applications. Stainless-steel clad bars have been evaluated in the FHWA time-to-corrosion studies.¹³⁰ They were found to reduce the frequency of corrosion-induced cracking compared with uncoated carbon steel in the test slabs, but did not prevent it. It was not determined, however, whether the cracking was from corrosion of the stainless steel or corrosion of the base carbon steel at flaws in the cladding.

3.4.2 Coatings—Metallic coatings for steel reinforcement fall into two categories: sacrificial or noble (nonsacrificial). In general, metals with a more negative corrosion potential (less noble) than steel, such as zinc and cadmium, give sacrificial protection to the steel. If the coating is damaged, a galvanic couple is formed in which the coating is the anode.

*“Voluntary Certification Program for Fusion-Bonded Epoxy Coating Applicator Plants,” CRSI, Schaumburg, Ill., 1991.

Noble coatings, such as copper and nickel, protect the steel as long as the coating is unbroken because any exposed steel is anodic to the coating. Even where steel is not exposed, macrocell corrosion of the coating may occur in concrete through a mechanism similar to the corrosion of uncoated steel.

Nickel,^{131,132} cadmium,¹³³ and zinc^{131,134,135} have all been shown to be capable of delaying, and in some cases preventing, the corrosion of reinforcing steel in concrete, but only zinc-coated (galvanized) reinforcing bars are commonly available.

Results of the performance of galvanized reinforcing bars have been conflicting, in some cases, extending the time-to-cracking of laboratory specimens,¹³⁶ in others reducing it,¹³⁷ and sometimes giving mixed results.¹³⁸ It is known that zinc will corrode in concrete^{132,139} and that pitting can occur under conditions of nonuniform exposure in the presence of high chloride concentrations.¹⁴⁰ Field studies¹³⁵ of embedded galvanized bars in service for many years in either a marine environment or exposed to deicing salts have failed to show any deficiencies. In these studies, however, chloride-ion concentrations at the level of the reinforcing steel were low, so that the effectiveness could not be established conclusively. Marine studies¹⁴¹ and accelerated field studies¹⁴² have shown that galvanizing will delay the onset of delaminations and spalls, but will not prevent them. In general, it appears that only a slight increase in service life will be obtained in severe chloride environments.¹⁴³ When galvanized reinforcing bars are used, all bars and hardware in the exposed portions of the structure should be coated with zinc to prevent galvanic coupling between coated and uncoated steel.¹⁴³

Numerous nonmetallic coatings for steel reinforcement have been evaluated,¹⁴⁴⁻¹⁴⁷ but only fusion-bonded epoxy powder coatings are produced commercially and widely used. The epoxy coating isolates the steel from contact with oxygen, moisture, and chlorides and inhibits the passage of an electrochemically produced current.

The process of coating the reinforcing steel with the epoxy consists of electrostatically applying finely divided epoxy powder to thoroughly cleaned and heated bars. Many plants operate a continuous production line, and many have been constructed specifically for coating reinforcing steel. Integrity of the coating is monitored by electrical holiday detectors and resistance to cracking during bend tests using procedures such as those detailed in ASTM A 775. The use of epoxy-coated reinforcing steel has increased substantially since its first use in 1973.

The Concrete Reinforcing Steel Institute (CRSI) has implemented a voluntary certification program* for plants applying fusion-bonded epoxy coating to address concerns over the quality of the manufactured coated bars. This industry-sponsored program was developed to provide independent certification that a particular plant and its personnel are equipped, able, and trained to produce coated reinforcement in conformance with the latest industry standards.

The purpose of the certification program is to ensure a high level of excellence in plant facilities and production operations, assist plant management, and provide recognition to plants that demonstrate a high level of excellence.

The chief difficulty in using epoxy-coated bars has been in preventing damage to the coating in transportation and handling. Specifically, damage can result from poor storage methods, rough installation, impact from hand tools, and contact with immersion vibrators. Cracking of the coating has also been observed during fabrication of precoated bars where there has been inadequate cleaning of the bar before coating or the thickness of the coating has been outside specified tolerances. Padded bundling bands, closely spaced supports, and nonmetallic slings are required to prevent damage during transportation, handling, and storage at the job site. Coated tie wires, coated wire bar supports, and precast concrete block bar supports are needed to minimize damage to the bar coating during placing. Current practices require all damage to be repaired. If the total amount of damaged coating exceeds the limit in project specifications, the coated bar is unacceptable and must be replaced. Damaged coating is repaired using a two-component liquid epoxy, but it is more effective to adopt practices that prevent damage to the coating and limit the need for touch-up. Accelerated time-to-corrosion studies have shown that nicks and cuts in the coating do not cause rapid corrosion of the exposed steel and subsequent distress in the concrete.¹⁴⁸ The damaged coated bars, however, were not electrically connected to uncoated cathodic steel in the early accelerated tests. Subsequent tests¹⁴⁹ showed that even in the case of electrical coupling to large amounts of uncoated steel, the performance of damaged and nonspecification bars was good but not as good as when all the steel was coated. Consequently, for long life in severe chloride environments, consideration should be given to coating all the reinforcing steel. If only some of the steel is coated, precautions should be taken to ensure that the coated bars are not electrically coupled to large quantities of uncoated steel.

Early studies have demonstrated that epoxy-coated, deformed reinforcing bars embedded in concrete can have bond strengths and creep behavior equivalent to those of uncoated bars.^{150,151} Another study¹⁵² reported that epoxy-coated reinforcing bars have less slip resistance than reinforcing bars with normal mill-scale although, for the particular specimens tested, the epoxy-coated bars attained stress levels compatible with ACI tension development length requirements. In all instances, however, tension development lengths used for design purposes should be in accordance with ACI 318, which requires an increase in development lengths for epoxy-coated bars.

3.4.3 Chemical inhibitors—A corrosion inhibitor is an admixture that will either extend the time to corrosion initiation or significantly reduce the corrosion rate of embedded metal, or both, in concrete containing chlorides in excess of the accepted corrosion threshold value for the metal in untreated concrete. The mechanism of inhibition is complex, and no general theory is applicable to all situations.

The effectiveness of numerous chemicals as corrosion inhibitors for reinforcing steel in concrete^{129,153-162} has been studied. The compound groups investigated have been primarily chromates, phosphates, hypophosphites, alkalis, nitrites, fluorides, and amines. Some of these chemicals are

effective; others have produced conflicting results in laboratory tests. Some inhibitors that appear to be chemically effective may have adverse effects on the physical properties of the concrete. All inhibitors should be tested in concrete before use.

Calcium nitrite has been documented to be an effective inhibitor,¹⁶¹⁻¹⁶³ and since 1990, an admixture containing amines and fatty acid esters,^{157,158} and another consisting of alkanolamines^{159,160} have also been reported to be effective inhibitors. Studies continue on the effectiveness of corrosion inhibitors in new construction and in the repair and rehabilitation of existing structures.

Some admixtures, which were used to prevent corrosion of the reinforcing steel by waterproofing the concrete, notably silicones, have been found to be ineffective.¹⁵³

3.4.4 Cathodic protection—Although cathodic protection has been used to rehabilitate existing salt-contaminated concrete structures for over 25 years, its application to new reinforced concrete structures is relatively new. The cathodic current density necessary to maintain a passive layer on the reinforcing steel before the reinforced concrete is contaminated with chlorides; however, it is relatively low, and the chloride ion tends to migrate towards the anode. Typical operating current densities range between 0.2 and 2.0 mA/m² (0.02 – 0.2 mA/ft²) for cathodic protection of new reinforced concrete structures, compared with 2 to 20 mA/m² (0.2 – 2 mA/ft²) for existing salt-contaminated structures.¹⁶⁴ Cathodic protection can be used by itself or in conjunction with other methods of corrosion control.

CHAPTER 4—PROCEDURES FOR IDENTIFYING CORROSIVE ENVIRONMENTS AND ACTIVE CORROSION IN CONCRETE

4.1—Introduction

Corrosion-induced damage in reinforced concrete structures such as bridges, parking garages, and buildings, and the related cost for maintaining them in a serviceable condition, is a source of major concern for the owners of these structures. There have been many examples of severe corrosion-induced damage of such structures. The total cost of corrosion in reinforced concrete amounts to billions of dollars annually. The corrosion problem, which is primarily caused by chloride intrusion into concrete, is particularly acute in snow-belt areas where deicing salts are used and in coastal marine environments. Detecting corrosion in its early stages and developing repair, rehabilitation, and long-term protection strategies to extend the service life of structures are challenging tasks. Effective survey techniques are necessary to evaluate the corrosion status of structures and facilitate implementation of appropriate and timely remedial measures while allocating available resources in the most efficient manner.

Selecting the most technically viable and cost-effective remedial measure for a deteriorated reinforced concrete structure in a corrosive environment is a formidable task. The alternatives span the extremes of ‘do nothing’ to complete replacement of the structure. Most often, some type of corrosion prevention or rehabilitation measure is deemed appropriate, and the specific approach to be used needs to be

made. This process has historically been arduous, with no standards or other guidelines available to assist in the analysis. A step-by-step process, however, has evolved for the purpose of selecting a technically viable and cost-effective solution for a given structure in a corrosive environment. This methodology has been successfully applied to bridge structures and can be applied to any reinforced concrete structure in a corrosive environment.¹⁶⁵

The methodology includes the following steps:

1. Obtain information on the condition of the structure and its environment;
2. Apply engineering analysis to the information and defining a scope of work;
3. Conduct a thorough condition evaluation of the structure;
4. Analyze the condition evaluation data;
5. Develop a deterioration model for the subject structure;
6. Identify rehabilitation options that are viable for that particular structure;
7. Perform life-cycle cost analysis (LCCA); and
8. Define the most cost-effective alternative for rehabilitating the structure.

The first step in the methodology involves reviewing structural drawings, reports of previous condition surveys, and available information on the environmental conditions at the site. Acquired information should include the following:

- Location, size, type, and age of the structure;
- Any unusual design features;
- Environmental exposure conditions, such as temperature variations, marine environment, and precipitation;
- Reinforcing steel details;
- Type of reinforcement such as uncoated, epoxy-coated, galvanized, nonprestressed steel, or prestressing steel;
- Drainage details, maintenance, and repair history; and
- Presence of any corrosion-protection systems.

The second step entails engineering analysis of the obtained information to develop a specific scope of work that is followed in the third step in the process, which is to conduct a thorough condition survey of the structure. The condition survey involves performing appropriate field and laboratory tests to quantify the deterioration of the subject structure. The fourth step focuses on analyses of the field and laboratory test results, which then facilitates the next step in the process: development of a deterioration model. Deterioration models are a set of mathematical relationships between corrosion condition data and remaining service life, future condition of the structure, or estimated future damage. Several models have been proposed that predict remaining service life using different definitions of end of life.^{166,167} For any of these models to be functional, they have to be correlated with actual field conditions or a sufficiently large database. A deterioration model also provides information on the optimum time to repair or rehabilitate a given structure.¹⁶⁸ Detailed information on the service life prediction of concrete structures can be found in ACI 365R.

The condition survey data, the output from the deterioration model, and the amount of damage that can exist on a particular structure before it should be repaired are used in the next step, identifying rehabilitation options that are viable

for that particular structure. In this step, a number of options for rehabilitation are defined based on technical viability and desired service life of the structure.

The last step in the methodology is the LCCA, which compares and evaluates the total cost of competing rehabilitation options to satisfy identical functions based on the anticipated life of the rehabilitated structure.^{166,169} The value of a particular rehabilitation option includes not only its initial cost, but also the cost of using that option for the desired time period. To perform a LCCA, one must estimate the initial cost, maintenance cost, and service life for each rehabilitation strategy being considered. Finally, based on the LCCA results, the most cost-effective rehabilitation strategy can be selected.

The focus of this chapter is on technologies and instrumentation used for conducting condition evaluations of reinforced concrete structures, or Step 3 of the methodology, to identify corrosive environments and active areas of corrosion.

4.2—Condition evaluation of reinforced concrete structures

Over the years, a number of techniques and procedures have been developed to facilitate a proper condition assessment of a reinforced concrete structure. Judicious use of these techniques and proper data interpretation are required before arriving at a conclusion and implementing corrective action.

Several nondestructive test (NDT) methods are available for assessing, either indirectly or directly, the corrosion activity of reinforcing steel in concrete or future propensity for corrosion. Other test methods are also available for assessing the condition of the concrete. A typical condition survey therefore involves two interrelated aspects: corrosion of the reinforcing steel and concrete evaluation. ACI 228.2R provides details on the underlying principles of most of the NDT methods discussed in this chapter.

The objective of the condition survey is to determine the cause, extent, and magnitude of the reinforcing steel corrosion and what can be expected in the future with regard to continued deterioration. Based on the specific scope developed for the target structure, some or all of the procedures listed as follows would be utilized in the condition survey.

Methods for evaluating the corrosion of reinforcing steel:

- Visual inspection;
- Delamination survey;
- Concrete cover measurements;
- Chloride-ion content analyses;
- Depth-of-carbonation testing;
- Electrical-continuity testing;
- Concrete moisture and resistivity measurements;
- Corrosion potential mapping;
- Corrosion rate measurements; and
- Determination of cross section loss on reinforcing steel.

Concrete evaluation test methods:

- Visual inspection;
- Core collection and compressive strength testing (on cores or in place);
- Rapid chloride permeability testing; and
- Petrographic analysis.

Poston et al. summarizes various methods that can be used for conducting a condition assessment of concrete structures.¹⁷⁰

4.3—Corrosion evaluation methods

Good-quality concrete has excellent compressive strength but is relatively weak in tension. Hence, reinforcing steel is incorporated into structural concrete members primarily to resist tension. The reinforcing steel may be conventional (nonprestressed reinforcing bars or welded wire fabric), prestressed (high-strength steel tendons), or a combination of both.

Nonprestressed reinforcing steel usually consists of deformed bars and may be uncoated, epoxy-coated, or galvanized. Most reinforced concrete structures such as bridges, parking garages, and buildings contain nonprestressed reinforcing steel. Prestressed reinforcing steel is typically in the form of seven-wire strands or bars. There are two types of prestressed concrete: pretensioned and post-tensioned.

In pretensioned structures, the tendons are first stressed to a predetermined force in a prestressing bed. Concrete is then cast in the bed and, once it has gained sufficient strength, the prestressing force on the tendons is released. The tendency for the prestressing steel within the hardened concrete to contract places the concrete in a state of residual compression and thus the prestressed concrete element is able to resist greater loads in service. Examples of pretensioned concrete components include beams, columns, and pilings.

In modern post-tensioned structures, the prestressing tendons are contained in ducts that are, in turn, positioned in the formwork. Concrete is cast, and after it has hardened and gained sufficient strength, the tendons in the ducts are tensioned and the two ends are anchored. As in the case of pretensioned concrete, compressive stresses are imparted to the concrete. In unbonded post-tensioning, the tendons are anchored only at anchorages at the ends of the structural member. Tendons in unbonded post-tensioned concrete are typically coated with grease that contains a corrosion inhibitor. In some cases, a grout slurry is pumped into the duct after the post-tensioning process. This is referred to as bonded post-tensioning. Examples of post-tensioned concrete components include parking garages, balcony slabs, and bridges.

Corrosion-evaluation methods are primarily oriented towards concrete structures with nonprestressed reinforcement. Some methods, particularly those that directly measure corrosion, are not applicable to post-tensioned structures for reasons that are discussed in [Section 4.3.2](#).

4.3.1 Nonprestressed reinforced concrete structures—The different test methods that can be used to identify corrosive environments and active corrosion in structures with nonprestressed reinforcement are discussed as follows.

4.3.1.1 Visual inspection—A visual inspection or condition survey is the first step in the evaluation of a structure for assessing the extent of corrosion-induced damage and the general condition of the concrete. A visual survey includes documentation of cracks, spalls, rust stains, pop-outs, scaling, and other visual evidences of physical deterioration of the concrete. The size and visual condition of any previous patch repairs should be also documented. In addition, the

condition of any existing corrosion protection systems or materials and drainage conditions, in particular evidence of poor drainage, should be recorded.

The visual survey information is recorded on a scaled drawing of the structure. A visual inspection is a vital part of the evaluation because the use of subsequent test procedures depends on the visual assessment of the structure. The inspection should follow an orderly progression over the structure so that no sections of the structure are overlooked.

ACI 201.1R provides guidelines for conducting visual inspection surveys on all types of reinforced concrete structures along with photographic examples of typical concrete defects.

4.3.1.2 Delamination survey—The most important form of deterioration induced by corrosion of reinforcing steel is delamination of the concrete. A delamination is a separation of concrete planes, generally parallel to the reinforcement, resulting from the expansive forces of corrosion products. Depending on the ratio of concrete cover to bar spacing, the fracture planes will either form V-shaped trenches, corner cracks, or a delamination at the level of the reinforcing steel parallel to the surface of the concrete. The extent of delaminations increases with time due to continuation of the corrosion process, cycles of freezing and thawing, and impact of traffic. Upon attainment of critical size, a delamination will result in a spall. As part of any repair or rehabilitation scheme, delaminated concrete should be removed, corroded reinforcement should be treated, and the areas where concrete was removed should be patched. The extent of concrete delamination influences the selection of cost-effective repair, rehabilitation, and long-term protection strategies.

Several different techniques, based upon mechanical, electromagnetic, or thermal principles, are presently available to detect delaminations. Sounding techniques, such as striking with a chain, rod, or hammer, impact-echo (or pulse-echo), impulse response, and ultrasonic pulse velocity are examples of mechanical energy-based systems. Short-pulse, ground-penetrating radar (GPR) is an electromagnetic energy-based system; infrared (IR) thermography is a thermal energy-based system.

The most commonly used and least expensive method for determining the existence and extent of delaminations is sounding with a chain, hammer, or steel rod. Depending upon the orientation and accessibility of the concrete surface, the concrete is struck with a hammer or rod, or a chain is dragged across the surface. Concrete with no delaminations produces a sharp ringing tone; delaminated areas emit a dull, hollow tone. ASTM C 4580 describes this test method. For large horizontal areas, such as highway bridge decks, a chain is dragged along the concrete surface to locate delaminations. The edges of delaminated areas are then defined using a steel rod or hammer. Vertical surfaces and the bottom surfaces of slabs or other overhead areas are more easily tested with a hammer or steel rod. Delaminated areas are outlined on the concrete surface and subsequently transferred to survey drawings with reference to the survey grid coordinates. Delaminated areas are often approximated as rectangles to facilitate saw-cutting their perimeter prior to removing the delaminated concrete.

The sounding technique depends on operator judgment and is prone to operator errors. Operator fatigue and high background noise levels can also reduce the accuracy and speed of the survey.

To overcome these problems, the Texas Department of Transportation automated the sounding technique with the development of the Delamtect[®] in 1973.^{171,172} The essential components of the Delamtect[®] consist of automated tappers, a strip chart recorder, and acoustic receivers. The Kansas DOT and the Iowa DOT improved the technique and developed appropriate software to expedite data processing. Use of the Delamtect[®] has been very limited.

Other mechanical energy-based devices, such as the ultrasonic pulse velocity, the impact-echo, and the impulse response methods, have been evaluated for detecting delaminations but have not been implemented on a widespread basis. The ultrasonic pulse velocity method is a proven technique for detecting flaws, such as voids and cracks, in concrete as well as determining concrete properties, such as the modulus of elasticity and density (ASTM C 597). This technique has been demonstrated to accurately detect delaminations, if through transmission of the ultrasonic pulse is possible. A large number of tests is required, however, because measurements have to be conducted on a fine grid.

The impact-echo technique can detect internal concrete defects, such as voids, cracks, or delaminations in concrete structures.^{173,174} In this method, a broad-band displacement transducer measures surface displacements resulting from the propagation of stress waves generated by an external impact. Differences in the characteristics of the reflected signals are used to locate internal defects in the concrete. Interpreting impact-echo data requires expert knowledge and experience. Additionally, a large number of tests is required because measurements have to be conducted on a fine grid to obtain meaningful results. The impact-echo method can also be effectively used to determine the thickness of in-place concrete slabs and ASTM has developed a standard for this purpose (ASTM C 1383).

Commercial GPR and IR thermography systems are relatively new developments for detecting delamination. Short-pulse GPR is a unique type of radar design based on the necessary tradeoff between propagation depth through solid, nonmetallic materials, and resolution in the medium. IR thermography relies on thermal differentials in the medium to detect defects.

4.3.1.2.a GPR survey—The use of GPR as a nonintrusive method of detecting deterioration in concrete bridge decks was first reported in 1977,¹⁷⁵ and additional work resulted in improvements in the accuracy of the technique.¹⁷⁶⁻¹⁷⁸ GPR technology was studied in depth under the Strategic Highway Research Program (SHRP) research efforts and is considered to be a viable technique for detecting deterioration in reinforced concrete.¹⁷⁹ Based on the SHRP work, AASHTO has developed a provisional standard for evaluating asphalt-covered bridge decks using GPR (AASHTO TP 36). The use of GPR to detect delaminations is also described in ASTM D 6087.

GPR is analogous to the echo methods (impact echo or pulse echo) used for delamination detection, except that GPR uses electromagnetic waves instead of stress waves. Echoes and reflections of radio frequency waves originating at the interface between materials with different dielectric or conductive characteristics are analyzed to detect delaminations.

A short-pulse GPR typically emits precisely timed, very short pulses of low-power, radio-frequency energy. Each pulse lasts about 1 nanosecond and occurs at a rate greater than 1 million times per second. The transmitted pulse is radiated downward toward the concrete surface by an antenna. As the transmitted pulse encounters a difference in dielectric property or conductivity, a portion of the radio frequency wave is reflected and the remaining portion propagates through the medium. The reflected waves are picked up by the antenna, fed to a receiver, and processed for display and analysis.

GPR can be used on bare and asphalt-covered concrete to identify areas that are obviously or very probably deteriorated. Depending on the concrete quality, moisture content, and thickness of the asphalt overlay, GPR will either directly identify delaminations or detect moisture and chloride ions in cracks. In dry, low-permeability concrete (a low-loss medium), radar has difficulty in identifying delaminations with sufficient accuracy. Accuracy can be further reduced if either the concrete cover or the asphalt overlay thickness is small, or both. GPR is more accurate in detecting delaminations that are filled with moisture and chloride ions.¹⁷⁹

Rapid improvement of computer hardware and software over the last few years has had a tremendous impact on GPR technology. Data acquisition, processing, and interpretation have become much more efficient and relatively simpler. Expert knowledge, however, is still required. GPR vehicles with multiple radar antennas have been developed. The latest GPR device, recently developed at the Lawrence Livermore Laboratories under FHWA funding, has a 64-channel antenna array covering a width of 1.9 m (6.2 ft) and operates at normal traffic speeds.¹⁸⁰ GPR surveys can be conducted at highway speeds, but for accurate results, surveys are best carried out at speeds of 24 to 32 kph (15 to 20 mph). Additionally, GPR surveys require minimal traffic control, which makes the technique attractive for application on bridge structures.

4.3.1.2.b IR survey—IR thermography was initially developed as a pavement inspection tool in the late 1970s and early 1980s.^{181,182} The IR technique can be used to identify delaminations in reinforced concrete structures by observing the effects of temperature differential between delaminated and sound reinforced concrete under certain environmental conditions.¹⁸³ Use of IR thermography as a viable nondestructive technique for detecting delaminations in concrete bridge decks was initiated in the 1980s and was applied successfully to some bridge structures.¹⁸⁴⁻¹⁸⁶ ASTM has developed a standard test method for detecting delaminations in bridge decks using IR thermography (ASTM D 4788).

Anomalies in the emission of thermal radiation, surface radiance, from a concrete surface are picked up in IR thermography and analyzed to detect delaminations. A delamination is marked by a separation of concrete planes. These separa-

tions are usually filled with air or moisture, both of which have different thermal properties compared with concrete. The difference in thermal properties impacts temperature gradients within the concrete and thermal radiation, particularly during cool-down and warm-up of the structure. With proper calibration, the thermal radiation can be converted to temperature, and variations in the surface temperatures detected by IR form the basis for identifying probable delaminations. Several handicaps exist. Differences in thermal gradients can be created by the sun shining directly on some sections of the structure and not on others and various other adverse climatic conditions. Interpretation of data under such conditions becomes difficult, and accuracy is reduced. Also, because IR can detect a 0.08 C (0.15 F) difference in temperature, even the outlines of a human hand placed on the concrete for 1 min can be detected. Such sensitivity makes interpretation of data even more complicated and prone to error.

4.3.1.3 Concrete cover measurements—The depth of concrete cover over the reinforcing steel has a great influence on the time to corrosion initiation of the reinforcing steel. A shallow concrete cover obviously allows easier access of deleterious substances, which leads to more rapid corrosion of the reinforcing steel and subsequent deterioration of the structure if other environmental conditions are conducive. Locating reinforcing steel is also essential in conducting corrosion condition surveys. The location of the reinforcing steel and the depth of concrete cover can be determined nondestructively using a device called a covermeter, pachometer, or reinforcing steel locator. Alternatively, GPR can be used to locate reinforcing steel, and small-diameter holes can be drilled to expose reinforcing steel for direct measurement of concrete cover. Concrete cover information is valuable in assessing the corrosion susceptibility of reinforcing steel and deviations from original contract documents, particularly, the project or as-built drawings for the reinforcement.

A covermeter measures variations in either magnetic flux or magnetic fields induced by eddy currents, due to the presence of steel, to locate reinforcement and determine the depth of concrete cover. The accuracy of covermeters varies, but generally, it is very accurate. Cover measurements have less error when the structure is lightly reinforced. For accurate cover measurements, prior knowledge of the size of the reinforcing steel is necessary. A few covermeters can estimate the size of reinforcement within two bar sizes, and some can also store measurements and transmit them to a computer.

Commercially available covermeters are compact, with single-element, hand-held probes, and are very useful for locating and determining the concrete cover over individual reinforcing bars. Obtaining cover measurements over large areas of a structure, however, is time-consuming and tedious.

Single-point covermeters can be used to develop depth-of-cover maps in the same way as half-cell potential maps are produced. The covermeter is used to determine the depth of cover at individual grid points on the structure. These readings are then recorded on a standard data form with reference to the grid coordinates. Results can then be entered manually into a computer or transmitted directly to generate concrete cover maps. There is no standard test procedure for conducting

cover measurements. Additional information on covermeters is given in ACI 228.2R.

4.3.1.4 Chloride-ion content analysis—Chloride ions are a major contributing factor in the corrosion of steel in concrete, provided sufficient moisture and oxygen are present. Chloride sampling and analysis methods for laboratory and field determinations are discussed in the sections that follow.

4.3.1.4.a Chloride sampling—The chloride content in concrete is determined through analysis of powdered concrete samples. Samples can be collected on site at different depths up to and beyond the level of the reinforcing steel using a hammer drill (AASHTO T 260). Care should be exercised to avoid inadvertent contamination of the samples. Alternatively, cores can be collected and powdered samples can be obtained at different depths in the laboratory. The latter method provides better control on sample depths and greatly reduces the risk of contamination.

4.3.1.4.b Chloride analysis: laboratory method—The chloride-ion content of concrete is usually measured in the laboratory using wet chemical analysis, for example AASHTO T-260, ASTM C 1152, and ASTM C 1218. Separate procedures are available for determining water-soluble and acid-soluble chloride content. Another procedure available for water-soluble chloride content analysis is known as the Soxhlet extraction technique, which involves a method of refluxing concrete chips in boiling water (ACI 222.1). Determination of chloride concentration in hardened concrete most often involves acid-soluble chloride content analysis, which is achieved through the standardized acid extraction test given in AASHTO T-260. Total chloride content analysis in concrete is typically performed because bound chlorides in the concrete can become unbound as a result of chemical reactions within the concrete over a period of time.¹⁸⁷ For example, relatively insoluble chloroaluminate, which is formed when chlorides are present in fresh concrete, may convert with time and exposure to sulfoaluminate and carboaluminate, releasing free chloride ions.¹⁸⁷ Additionally, the acid extraction test is more reproducible and less time-consuming than water-soluble chloride analysis procedures and has become more accepted.^{188,189}

Chloride content results are reported in percent chloride by mass of concrete, parts per million (ppm) chloride, percent chloride by mass of cement, or kilograms per cubic meter (pounds of chloride per cubic yard) of concrete. The results can be easily converted from one unit to another using appropriate conversion factors.^{189,190}

4.3.1.4.c Chloride analysis: field method—Although laboratory testing is most accurate, it is also time-consuming, often taking several weeks before results are available. As a result, field test kits have been developed. Two commercial units are available, both of which use a specific ion electrode. Field test kits allow rapid determination of chloride levels to be made on site. Some precautions need to be taken. Recently, a report evaluated the accuracy of the two chloride test kits against the AASHTO laboratory method.¹⁹¹ The primary conclusion was that both test kits correlate well with the AASHTO method at chloride concentrations between approximately 0.010 and 0.350% (0.20 and 8.10 kg/m³ or

0.40 and 13.70 lb/yd³) by mass of concrete. Two kits gave results that represented approximately 57 to 62% of the AASHTO values. Therefore, depending on the particular field kit used, a correction factor must be applied to obtain accurate results.

The SHRP research effort evaluated one of the field test kits and arrived at the same conclusion.¹⁹² Accordingly, some modifications were made to the test procedure. The SHRP-modified field chloride test method has been incorporated in the latest version of AASHTO T-260 as an alternative to the more frequently used potentiometric titration method. It is important to note that some errors exist in the SHRP developed equations and these have been partly transferred to the AASHTO T-260 document.¹⁹³

4.3.1.5 Depth of carbonation testing—Carbonation testing can be carried out on site at a later time using core samples that have been carefully preserved or during petrographic analysis. The depth of carbonation is measured by exposing a fresh concrete surface and applying a solution of phenolphthalein in ethanol. Phenolphthalein is a clear pH indicator that turns magenta (or a pink tint) at or above a pH of approximately 9. Therefore, when applied to a freshly exposed concrete surface, the solution will indicate areas of reduced alkalinity. The magenta areas indicate uncarbonated concrete; the colorless areas indicate carbonated concrete. Because of the presence of porous aggregates, voids, and cracks, the carbonation front only approximates a straight line parallel to the concrete surface. No consensus standard is currently available for this test technique.

The depth-of-carbonation test is most important for older reinforced concrete structures. If carbonation is a contributing factor to the deterioration of a given structure and it is not accounted for, one can expect future premature damage after repairs are completed.

4.3.1.6 Electrical continuity testing—This test is performed to determine whether or not various embedded metallic elements are in electrical contact with each other. The test has three purposes:

1. Results of this test are needed before conducting corrosion potential surveys (corrosion potential mapping) and rate of corrosion tests on the reinforcing steel;
2. Direct contact between reinforcing steel and other metals can lead to accelerated corrosion of the steel if the steel is more anodic with respect to the metal, for example aluminum; and
3. The state of electrical continuity of all embedded metals must be known when considering electrochemical options for protection against corrosion.

The corrosion potential survey is particularly sensitive to continuity because all the reinforcing steel within a given potential survey area must be electrically continuous if data are to be collected in a grid pattern. If the ground connection is made to a reinforcing bar or other metallic element that is electrically isolated from the reinforcing steel in the survey area, the readings will essentially be remote corrosion-potential measurements of the isolated ground and are meaningless. The same is true for rate-of-corrosion testing. If reinforcing steel within a survey area is electrically discontinuous, sepa-

rate ground connections must be made to each reinforcing bar where corrosion measurements will be made.

Wire bar supports, direct contact at crossings, and wire ties normally provide good electrical continuity throughout cast-in-place sections of a reinforced concrete structure. Precast reinforced concrete members also exhibit good electrical continuity. Electrical continuity, however, should always be verified during a condition survey. Continuity across expansion joints, between scuppers and reinforcing steel, and between railings and reinforcing steel is always suspect and requires verification. Any metallic element can be used as the ground location for testing if it is electrically continuous to the reinforcing steel being tested. During the survey planning stage, proposed potential grid map locations should be laid out to avoid spanning obvious discontinuities.

Theoretically, when epoxy-coated reinforcing bars are used, every bar should be electrically isolated or, in other words, electrically discontinuous. Testing on existing structures with epoxy-coated reinforcing bars, however, has shown that the degree of electrical continuity can range from none to complete depending upon the structure. Therefore, before conducting electrical tests on epoxy-coated reinforcing bars, each bar should be tested for electrical continuity.

4.3.1.6.a Test procedure—Reinforcing steel must be exposed so that electrical contact to individual bars can be made. If the reinforcing bars are not exposed, a pachometer should be used to locate them (Section 4.3.1.3). Once located, the reinforcing bars can be exposed by coring or rotary hammer. There are several test methods for checking electrical continuity:

- **DC resistance.** The resistance between two metallic elements is measured with a high impedance multimeter with lead polarity normal and reversed. Resistance values greater than one ohm indicate discontinuity;
- **DC voltage difference.** The potential difference between two metallic elements is measured with a high impedance multimeter. Potential differences greater than one mV indicate discontinuity;
- **AC resistance.** The AC resistance between two metallic elements is measured with an AC bridge null resistance meter. AC resistance values greater than one ohm indicate discontinuity; and
- **Half-cell potentials.** The potential of several metallic elements to be tested is measured against a reference cell placed at a fixed location on the concrete surface. Potential measurements greater than 3 mV indicate electrical discontinuity.

None of these methods provide a definite assurance of continuity. Each test requires a degree of interpretation and experience to confirm electrical continuity, because the cut-off level of acceptable results is not a definite point. All four test methods, however, will provide a definite indication of discontinuity. The DC resistance and voltage difference methods are the most commonly used for electrical continuity testing. No consensus standard is currently available for these test methods.

4.3.1.7 Concrete moisture and resistivity measurements—The moisture content in concrete has a significant

impact on many deterioration processes, including corrosion of reinforcement, alkali-silica reaction, freezing and thawing, and sulfate attack. The resistivity of the concrete, which is a function of the moisture and electrolyte content, has an important bearing on the rate of corrosion of embedded reinforcing steel. Consequently, it is sometimes desirable to measure concrete moisture content and resistivity. It is not common practice, however, to determine these parameters, and no standard test procedures are currently available.

One method of determining the moisture content of concrete is to measure the relative humidity in the concrete. Several different probes are available that use the dependence of electrical resistivity of certain materials on the relative humidity of the surrounding environment. To measure humidity, a probe is sealed in a hole in the concrete. A portable meter is then used to measure the relative humidity inside the hole. This method can monitor relative humidity changes with time and provide insight into moisture cycling in a reinforced concrete structural member.

A relationship between electrical resistivity of concrete and rate of corrosion of embedded reinforcing steel is widely acknowledged. Studies have been conducted to directly relate concrete resistivity with corrosion rate of reinforcing steel.¹⁹⁴⁻¹⁹⁷ Under field conditions, there is a direct correlation between concrete resistivity and rate of corrosion of reinforcing steel.¹⁹⁵ Conditions such as high pore-water content and the presence of electrolyte salts that lead to low resistivity usually favor active corrosion. Conversely, high concrete resistivity implies a high electrolyte resistance, which limits the rate of corrosion. Significant corrosion is not likely when the resistivity exceeds 8500 to 12,000 ohm-cm.¹⁹⁸

Concrete resistivity can be measured using a modification of the Wenner four-electrode technique commonly used for measuring soil resistivity (ASTM G 57). The modified procedure involves installing four equally spaced probes in a straight line on the concrete to be tested. The probe spacing is equal to the depth to which measurement of the average resistivity is desired. The average resistivity is a function of the voltage drop between the center pair of probes with current flowing between the two outside probes. Unlike resistivity measurements in soil, particular care has to be taken during measurements in concrete to overcome the high contact resistance between the probes and the concrete surface. This is achieved by using a conductive interface, such as a sponge or wooden plug, at the probe tips and by grinding the concrete surface before taking measurements at each location.

Less expensive and less accurate two-probe systems are available. Another approach for measuring resistivity is to use a single electrode on the concrete surface and another on the reinforcing steel within the concrete. The advantage of this technique is that only the resistivity of the concrete cover is measured. The disadvantage is that this method suffers from contact resistance problems.¹⁸⁸

Table 4.1 provides guidelines for interpreting resistivity measurements from the Wenner four-probe system when referring to corroding reinforcing steel embedded in concrete.¹⁸⁸ Concrete resistivity is a useful additional measurement for identifying problem areas or confirming concerns

Table 4.1—Relationship between concrete resistivity and corrosion rate

Resistivity, k Ω -cm	Corrosion rate
> 20	Low
10 to 20	Low to moderate
5 to 10	High
< 5	Very high

about poor quality concrete, although the data should be considered along with other measurements.¹⁸⁸

4.3.1.8 Corrosion-potential mapping—Corrosion is an electrochemical process, and potential (voltage) is one of the parameters that can indicate the state of the process. Corrosion-potential measurements provide an indication of the state of corrosion and not the rate of corrosion. The corrosion rate is a function of many parameters, such as temperature, equilibrium potential, concrete resistivity, ratio of anodic and cathodic areas, and rate of diffusion of oxygen to cathodic sites. A standard test method for conducting corrosion potential surveys on uncoated reinforcing steel embedded in concrete, ASTM C 876, is available.

Caution should be exercised in interpreting corrosion potential data. Many conditions can affect the measured potentials and lead to inaccurate assessment of the corrosion status of the embedded reinforcing steel. Examples of these conditions include carbonated concrete, fully water-saturated concrete, electrical discontinuity of the reinforcing steel grid, presence of stray currents, presence of epoxy-coated reinforcing steel, presence of galvanized reinforcing steel, presence of other embedded metals, availability of oxygen, and the effect of the contact medium used for the survey. In addition, corrosion-potential measurements should not be taken in areas with delaminated concrete.

One of the most important applications of the corrosion-potential survey is to develop a history of the reinforced concrete structure. For example, if corrosion-potential surveys are conducted at regular intervals of time, then the corrosion activity of the reinforcing steel with time can be readily ascertained. In other words, trends of potential with time can indicate with good confidence if reinforcing steel corrosion activity in undamaged concrete is increasing with time or if the total area of reinforcing steel showing active potentials is increasing. Such information can be valuable in making decisions regarding maintenance or repair. Corrosion potential mapping has been used extensively to determine the probability and extent of active corrosion of uncoated reinforcing steel in both field concrete structures and laboratory specimens.¹⁹⁹⁻²⁰⁵

Another important application of corrosion-potential mapping is to delineate active corrosion spots, typically locations with high negative potentials, on the structure. Rate-of-corrosion measurements can then be performed in the areas that are active.

4.3.1.8.a Procedure and instrumentation for corrosion potential measurement—The voltage reading between a standard portable half-cell placed on the surface of the concrete and the reinforcing steel bar located below the surface is compared with values that have been empirically devel-

oped to indicate relative probabilities of corrosion activity. A portable copper-copper sulfate (CSE) half-cell electrode is normally used for field readings. A moist sponge is attached to the tip of the electrode to reduce the electrical resistance between the concrete surface and the electrode. A wetting solution is used for moistening the sponge. Other reference half-cells, such as silver-silver chloride (Ag-AgCl) or calomel (Hg-Hg₂Cl₂) can also be used. The CSE is popular because it is rugged and stable. Copper is easily maintained at a standard potential over a wide range of conditions provided that it is submerged in an electrolyte saturated with copper sulfate crystals.

Corrosion potentials can be measured manually with any good-quality 31/2 digit, high-impedance (10 megaohms or greater) voltmeter, or data loggers. Corrosion potential surveys should be carried out on a regular interval grid. Depending on the size of the structure and the grid interval, the quantity of data collected can vary from a few to several thousand numbers. Large areas are usually mapped with an electrode spacing of 0.6 to 1.5 m (2 to 5 ft), whereas small areas are usually mapped with a spacing of 0.15 to 0.30 m (6 in. to 1 ft). A prerequisite for corrosion-potential surveys is to establish that the reinforcing steel in the structural component is electrically continuous. If the underlying reinforcing steel is not electrically continuous, each area to be surveyed must have a unique ground point. If electrical continuity exists, a common ground point can be used for several survey areas. The ground point can be established by exposing an area on the reinforcing steel and drilling a hole in the bar. A self-tapping screw is then driven into the hole and the test lead wire is clamped to the screw head. With this method, less concrete is removed, and a good connection is achieved.

As with many other technical fields, advances in computer and electronic technology have significantly enhanced data collection and processing. Several commercial instruments that record and store multiple readings are available. These units are equipped with a data logger to collect data in real time and store them for later processing. Data stored in the data logger are transferred to a computer for manipulation and creating equipotential maps.

Some systems use multicell arrays so that more than one potential reading can be recorded simultaneously. These units allow large areas to be surveyed thoroughly and efficiently. Another type of potential measurement device consists of wheel electrodes. One or more miniature reference electrodes are installed along the periphery of the wheels. Potentials are recorded in a data logger as the wheels are rolled along the surface of the concrete. Some degree of familiarity and experience is required to use the computerized equipment. Several systems for mapping corrosion potential have been evaluated competitively.²⁰⁶

4.3.1.8.b Corrosion potential data interpretation—The corrosion potential of reinforcing steel indicates whether or not the steel is actively corroding the area of measure at the time the measurement is obtained. The following guidelines are given in a nonmandatory appendix of ASTM C 876 for interpreting corrosion-potential data of uncoated reinforcing steel in concrete.

- If potentials over an area are more positive than -0.20 V CSE, there is a greater than 90% probability that no reinforcing steel corrosion is occurring in that area at the time of measurement;
- If potentials over an area are in the range of -0.20 to -0.35 V CSE, corrosion activity of the reinforcing steel in that area is uncertain; and
- If potentials over an area are more negative than -0.35 V CSE, there is a greater than 90% probability that reinforcing steel corrosion is occurring in that area at the time of measurement.

(Note: These guidelines should only be used for uncoated conventional reinforcing steel embedded in concrete. Data interpretation guidelines have not been developed for epoxy-coated or galvanized reinforcement and prestressing steel).

Differences in corrosion potentials across a structure or in an area of a particular reinforced concrete member are better indicators of the level of corrosion activity than the absolute potential values. For example, a 1.5 m (5 ft) square section of slab that has potentials that vary 100 mV is more active than a similar section with a 30 mV variation. The chloride level at the surface of the reinforcing steel and other factors such as temperature must also be considered when evaluating corrosion potential readings. ASTM C 876 stipulates a temperature correction if the temperature during the corrosion-potential survey is outside the range of 22.0 ± 5.5 C (72 ± 10 F).

4.3.1.9 Corrosion rate measurements—Because corrosion is an electrochemical process, it can be monitored with electrochemical techniques. Several options are available and can be broadly classified as either transient or steady-state techniques. Examples of steady-state techniques include Tafel extrapolation (E -log I) and linear polarization resistance (LPR); while potential step, small-amplitude cyclic voltametry, electrochemical noise, and AC impedance measurements are classified as transient methods.²⁰⁷ In the context of reinforcing steel in concrete, the LPR, Tafel extrapolation, AC impedance, and electrochemical noise techniques have been successfully used for rate of corrosion (ROC) measurements, and LPR has become the technique of choice.

The LPR technique provides a reliable and simple method for determining instantaneous corrosion rates and has been used in electrochemical laboratories for decades for measuring corrosion rates of metals in aqueous environments. The LPR technique was validated as a means of estimating the rate of corrosion of steel in concrete in laboratory work performed at the U.S. National Bureau of Standards, now known as the National Institute for Standards and Technology (NIST), and equipment and procedures for field applications on reinforced concrete structures have been developed.^{208,209} The rate-of-corrosion measurement technique and three rate-of-corrosion devices for concrete were evaluated under the SHRP program.²⁰⁷ Two of the devices used the LPR technique, while the third device used the AC impedance technique. There is no standard procedure for rate-of-corrosion measurements; however, AASHTO is developing a standard practice based on the SHRP work.

The rate-of-corrosion test provides information on the rate at which reinforcing steel is being oxidized. The higher the

rate, the sooner concrete cracking and spalling will appear. Therefore, this information can be useful in estimating the time to additional damage and in selecting cost-effective repair and long-term corrosion-protection systems. Several attempts have been made to correlate corrosion rate to the remaining service life of structures or time to damage. Based on experience, one manufacturer of a corrosion-rate device provides guidelines for interpreting the data in terms of time to damage, while others have attempted to mathematically model remaining life based on corrosion rate information. No such models or guidelines are universally accepted.

4.3.1.9.a The LPR technique—The three-electrode LPR technique is based on the assumption that small changes in the potential of a freely corroding metal, that is, a metal at a potential close to its corrosion potential, have a linear relationship with applied current. Additionally, the ratio of the change in potential (ΔE) to the applied current (ΔI), that is, $\Delta E/\Delta I$ or R_p , the polarization resistance, is inversely proportional to the corrosion current (I_{CORR}) and, in turn, to the corrosion rate of the metal.

The three electrodes in the LPR technique consist of a working electrode (WE), the reinforcing steel, a counter electrode (CE), usually a nonreactive metal, and a reference electrode (RE), for example, the copper-copper sulfate half-cell (CSE). The LPR device applies small voltage or current perturbations to the WE via the CE and the corresponding current or voltage responses are measured by the device. The RE measures the initial corrosion potential and any shift in potential of the WE and is not part of the current-carrying circuit. The voltage and current data are manipulated to obtain the polarization resistance R_p , which is then fitted into a mathematical formula known as the Stern-Geary equation to derive the corrosion rate.^{210,211} The Stern-Geary equation is represented as

$$I_{CORR} = (K/A) \cdot (\Delta I)/(\Delta E) = K/R_p \quad (4.1)$$

I_{CORR} = corrosion current density expressed in $\mu\text{A}/\text{cm}^2$ (or mA/ft^2);

K = proportionality constant expressed in mV/mA ;

A = area of reinforcing steel polarized;

ΔI = applied current required to obtain ΔE expressed in mA;

ΔE = voltage change resulting from the applied current expressed in mV; and

R_p = polarization resistance expressed in $\text{ohm}\cdot\text{cm}^2$ (or $\text{ohm}\cdot\text{ft}^2$).

The proportionality constant (K) is a function of the anodic and cathodic Tafel slopes (that is, the relationship between current and voltage levels outside the linear region) and depends on the particular system being polarized

$$K = \beta_a \beta_c / 2.3(\beta_a + \beta_c) \quad (4.2)$$

where β_a and β_c are the anodic and cathodic Tafel constants.

The use of an anodic Tafel slope of 150 mV/decade and a cathodic Tafel slope of 250 mV/decade has been suggested

for reinforced concrete.²⁰⁸ If one assumes uniform corrosion and a constant rate over time, I_{CORR} for reinforcing steel can be converted to a rate of thickness loss. To obtain units of $\mu\text{m}/\text{yr}$, multiply I_{CORR} by 12.5, or to obtain units of mils/yr , ($1 \text{ mil} = 1/1000 \text{ in.}$) multiply I_{CORR} by 0.492. The corrosion rate on existing reinforced-concrete structures, however, is not uniform or constant; therefore, calculating thickness losses with time can be misleading.

4.3.1.9.b *The AC impedance technique*—AC impedance methods record the impedance response offered by the system to AC signals over a range of frequencies.²¹² The real and imaginary components of the impedance are plotted. Such a plot should be a semicircle with polarization resistance R_p as its diameter. The high-frequency intercept on the real axis is the solution (concrete) resistance R_s , whereas the low-frequency intercept (approaching DC signals) on the real axis is the total impedance of the system, $R_p + R_s$. Therefore, subtracting the high-frequency intercept from the low-frequency intercept yields R_p , the polarization resistance, which can then be used in corrosion rate calculations. In practice, the plot deviates greatly from the semicircular shape. From a field application viewpoint, a complete frequency scan is simply too time-consuming and equipment is overly expensive and bulky. Because only the very low- and very high-frequency response data are needed to derive R_p , some devices scan only these two regions to measure this parameter, thereby reducing the time required to conduct the test. For every system under measurement, however, the low frequency that defines total impedance and the high frequency that defines solution resistance are the fundamental characteristics of that particular system, and a complete frequency scan is required to define them. Several equipment manufacturers have introduced portable equipment to conduct AC impedance tests in the field but have not been able to reduce the time required to conduct the test over the entire frequency range.

4.3.1.9.c *ROC field measurements*—Due to the natural heterogeneous nature of concrete, environmental variables such as temperature and humidity and the inability to position the corrosion rate probe very close to the reinforcing steel, corrosion-rate measurements have inherent error. It has been argued, however, that due to large differences in corrosion rates (several orders of magnitude) between passive and active reinforcing steel, the measurement errors do not significantly impact interpretation of results from an engineering point of view.

In a field test, one difficulty is to determine the area of steel tested. Knowing the steel area is important because the corrosion rate is defined in terms of the corrosion current per unit area of steel (for example, $\mu\text{A}/\text{cm}^2$ or mA/ft^2). The magnitude of the corrosion current measured is a direct indication of how fast corrosion is occurring on the steel surface. High currents indicate a high corrosion rate and vice versa.

Rate of corrosion measurements are usually conducted at the most active corrosion sites identified during the corrosion-potential survey. The rate of corrosion measurement is a point-in-time indicator. Temperature and concrete moisture content may change in a matter of days or even hours and result in corresponding changes in the corrosion rate.

Therefore, predicting future corrosion activity must include evaluation of dynamic environmental factors. The most active corrosion or highest corrosion rates may not be occurring at the time of the field survey. Continuous or intermittent monitoring over a period of time gives a more accurate appraisal.

SHRP identified several parameters that significantly impact corrosion rate measurements:²⁰⁷

- Proper electrical contact between the probe and the concrete;
- Symmetrical positioning of the probe over the reinforcing steel;
- Presence of a stable open-circuit (corrosion) potential;
- A guard ring of appropriate size and spacing to define the polarized area; and
- Measurements that are carried out over the active parts of macrocells.

4.3.1.9.d *Rate-of-corrosion equipment and data interpretation*—Rate-of-corrosion equipment consists of a measuring device and a suitable probe. Three commercial instruments are available for conducting ROC measurements on reinforced-concrete structures. All three instruments use the LPR technique. One of these devices is manually operated while the other two devices use microprocessor control and are fully automated. The automated devices utilize the guard-ring concept to measure the rate of corrosion.²¹³ Measurements made using the guard-ring have been found to be more accurate by up to two orders of magnitude where corrosion rates are low.²⁰⁷ Recently, a comparative evaluation was conducted on three commercial rate-of-corrosion devices.²¹⁴

Data interpretation guidelines range from projecting actual time to damage to representing corrosion rate in terms of a passive condition, low, moderate, or high corrosion, depending on the magnitude of the corrosion-current density. Interpreting rate-of-corrosion data in terms of a passive, active, or partially active corrosion condition has also been suggested.²¹⁵

4.3.1.10 *Cross-section loss of reinforcing steel bars*—This test is used to quantify the amount of corrosion that has occurred on reinforcing steel bars by directly measuring cross-sectional loss with a caliper. To make measurements, the reinforcing steel bar has to be exposed in spalled areas or carefully excavated. Additionally, the reinforcing steel bar must be cleaned of all corrosion products before taking measurements. This is not a standardized test, but is sometimes used to aid in determining structural integrity.

4.3.2 *Prestressed reinforcement*—Identifying corrosion in structural concrete containing prestressing steel is typically more difficult than in structural concrete containing nonprestressed reinforcement. Local corrosion of prestressed reinforcement can occur without any outward signs of concrete damage. Stress corrosion cracking and intergranular corrosion due to hydrogen embrittlement can also occur without local accumulation of corrosion products. All test methods used for corrosion assessment of reinforced concrete structures containing nonprestressed reinforcement can be used for pretensioned prestressed steel. On post-tensioned structures, some of the test methods (for example, corrosion po-

tential and corrosion rate) may be applicable only in anchorage areas. Although corrosion potential and corrosion rate readings may indicate corrosion of a metallic sheath (duct) or an anchorage, data interpretation is difficult if corrosion of nonprestressed reinforcement is occurring at the same time. It is not possible to detect corrosion of the prestressing steel using corrosion potential or corrosion-rate measurements when the steel is shielded by the sheath. The only method of determining corrosion of a post-tensioned tendon at a particular location is to remove the concrete around the tendon and observe the prestressing steel locally. This, however, does not provide any information regarding corrosion at other locations along the tendon.

A new nondestructive technique known as continuous acoustic monitoring (CAM) has been developed for detecting and monitoring damage in unbonded prestressed structures.²¹⁶ This system reports the time and location of tensioned prestressing-steel failures. When installed in a prestressed structure, the CAM system uses an array of sensors (one every 93 m² [1000 ft²] in a typical building) to record acoustic signals of tendon element failures. Proprietary software analyzes the recorded signals to filter out extraneous noise so that it can locate and identify failures. The system permits efficient continuous monitoring of large and small structures. By knowing the location and rate of failures after installation, it is possible to manage a known or suspected corrosion condition in a structure.

4.3.2.1 Pretensioned structures—Though all corrosion assessment techniques used for reinforced concrete can be applied to prestressed concrete as well, some tests should be used with caution. For pretensioned concrete structures, corrosion-potential readings are possible if corrosion of the nonprestressed reinforcing steel does not mask the behavior of the prestressing steel. Pretensioned steel may not be electrically interconnected, which makes corrosion potential readings more difficult to take and interpret. Additionally, the ASTM C 876 guidelines for interpreting corrosion potential readings are not applicable for prestressing steel.

4.3.2.2 Unbonded post-tensioned structures—Anchorage zones that show corrosion products and concrete distress are a sign of corrosion at the anchors and possibly corrosion of prestressing steel contiguous to the anchor in unbonded systems. If the sheath does not exclude water, then water ingress from the anchorage often results in corrosion of prestressing steel. Local removal of concrete from the anchorage area to observe prestressing steel corrosion is a limited sampling procedure that requires extreme caution. Another limited sampling procedure involves removing concrete and a portion of the duct at a specific location away from anchorages to observe the condition of the prestressing steel. This type of direct visual testing is commonly done at tendon hold-down points where water tends to accumulate.

Unlike nonprestressed reinforcement, corrosion products that form on unbonded tendons are contained within the sheathing and do not cause any cracking or spalling of the concrete. Cracking along the tendon trajectory, however, may occur because of freezing entrapped water inside the duct. This usually indicates prestressing corrosion, particularly

if chlorides are present. Because the tendon is unbonded, it can be removed and replaced in most cases. Removing the tendon is the only procedure available to completely assess the extent of corrosion along the tendon. Guidelines on tendon removal and replacement are provided in ACI 423.4R.

4.3.2.3 Bonded post-tensioned structures—In bonded post-tensioned structures, the prestressing steel is encased in a duct that is filled with grout. Corrosion can occur if water-filled voids exist in the grout. The impact-echo technique has been used successfully to detect voids in post-tensioned ducts.²¹⁷⁻²¹⁹ This technique is limited to accessible tendons and cannot be used for interior tendons in a multiple tendon configuration. Further, entrapped water may freeze and cause cracking following the trajectory of the tendon. Steel sheath corrosion may also provide enough corrosion products to cause cracking along the tendon.

4.4—Concrete evaluation test methods

Various test methods for assessing the condition of concrete on in-service structures are listed in Section 4.2 and are discussed as follows. Except for the visual inspection test procedure, the other tests for conducting concrete condition evaluations are of a destructive nature. They involve the extraction of core samples from the structure for subsequent testing and analysis.

4.4.1 Visual inspection—Visual inspection purposes and procedures are the same as for the corrosion condition evaluation of the structure. The methodology was discussed in detail in [Section 4.3.1.1](#).

4.4.2 Core collection and compressive-strength testing—Compressive-strength tests are usually conducted on 100 mm (4 in.) diameter core samples as per ASTM C 42 or AASHTO T-24. Compressive-strength testing is conducted to verify that the concrete compressive strength meets the specified requirements of the mixture design and also to determine if the strength has been compromised due to any deterioration process such as alkali-silica reaction (ASR) or freezing and thawing damage. Wide variations in compressive strength indicate local areas of deterioration. Concrete damaged by freezing and thawing action, usually exhibited as horizontal cracks in the upper portion of the core, may register a high compressive strength but still be of poor quality.

All cores collected from a structure should be identified by core number and grid location to the nearest 150 mm (6 in.). Each core taken should be photographed and its condition described. The cores should be arranged to show any significant deterioration, unusual features, and where possible, embedded steel reinforcement. In some cases, wetting the cores may improve the contrast and emphasize defects such as cracks and voids. A sketch should be made to show the overall dimensions of each core, the location of any reinforcement, and significant defects. The sketch should illustrate the same view of the core as in the photograph.

4.4.3 Chloride-ion permeability testing—The chloride-ion permeability of concrete is best determined by test procedures that measure actual chloride ingress. The rapid chloride permeability test, an electrical procedure described in AASHTO T-277 and ASTM C 1202, has gained acceptance

as a means of evaluating the ability of concrete to resist chloride-ion penetration. This accelerated laboratory test method consists of monitoring the amount of electrical current passed through a 50 mm (2 in.) thick slice of a 100 mm (4 in.) nominal diameter core or cylinder during a 6-h period under a potential difference of 60 volts. One end of the specimen is exposed to a sodium chloride solution and the other end is exposed to a sodium hydroxide solution. The total charged passed, in coulombs, is a function of the initial conductivity of the concrete and the change in conductivity during the test. Because concrete conductivity and chloride-ion penetration are both directly affected in part by the pore structure of the paste, the total charge passed provides a relative indication of the resistance to chloride-ion penetration. Therefore, for a given set of concrete-making ingredients, a high charge (> 4000 coulombs) indicates a relatively high chloride-ion permeability, while a low charge (< 100 coulombs) indicates negligible permeability.

Though the rapid chloride permeability test gives reasonable results for most concretes, caution should be used when the test is applied to concrete with relatively large quantities of admixtures containing inorganic salts, which increase the electrical conductivity of the concrete and make it appear more permeable. In addition, the test reflects the permeability of the concrete at the test age. For concrete that has been in place for many years, the test may indicate low permeability, yet chloride analyses may show high levels of chlorides present in the structure.

The rapid permeability test has been reviewed and simpler alternatives for determining chloride permeability have been suggested.^{199,220} According to these reviews, there are several errors in the test:

- The test uses the total current and not that corresponding to the chloride flux;
- When integrating the total current from the beginning of the experiment, the procedure does not distinguish between chloride flow plus reaction and simple flow; and
- The high voltage drop used induces heat which, in turn, changes the flow speed.

Therefore, a migration test, such as that used in the rapid permeability test, cannot accurately quantify the transport of chlorides, much less the porosity or permeability of the concrete specimen.²²⁰

4.4.4 Petrographic analysis—The ASTM C 856 standard test procedure for petrographic analysis consists of microscopic examination of a freshly fractured and polished concrete surface that is obtained from a 100 to 150 mm (4 to 6 in.) diameter drilled core. Collecting cores is prescribed by ASTM C 42. A qualified petrographer should perform the analysis. Petrographic examination is often supplemented with chemical analysis, x-ray diffraction analysis, and scanning electron microscopy.

Information obtained during a petrographic analysis can include the following:

- Condition of material;
- Causes of inferior quality;
- Identification of distress or deterioration caused by

chloride-induced corrosion, carbonation, alkali-aggregate reactions, and freezing and thawing cycles;

- Probable future performance;
- Compliance with project specifications;
- Degree of cement hydration;
- Estimation of w/cm and density (unit weight);
- Extent of paste carbonation;
- Presence of fly ash and estimation of amount of fly ash;
- Evidence of sulfate and other chemical attack;
- Identification of potentially reactive aggregates;
- Evidence of improper finishing;
- Estimation of air content and how much of the air voids are entrained versus entrapped;
- Evidence of early freezing; and
- Assessment of the cause of cracking.

CHAPTER 5—REMEDIAL MEASURES

5.1—Introduction

This chapter discusses measures available to stop or minimize corrosion activity on the embedded metal of an existing, structurally adequate, reinforced-concrete structure.

5.2—General

Remedial measures for controlling corrosion of reinforcing steel embedded in portland cement concrete use principles directed toward:

1. Insulating the concrete surfaces from the corrosive environment;
2. Modifying the environment to make it less corrosive; or
3. Modifying the electrochemical reactions at the reinforcing steel.

Several options are available for repair and rehabilitation of deteriorated reinforced concrete structures. Choosing an option depends on the observed deterioration, the environment, the availability of repair products, and the skill of the workforce used to implement the repair procedure. Some of the currently available options include:

- Do nothing;
- Remove spalled concrete and replace with a patch of overlay;
- Remove spalled and delaminated concrete and replace with a patch of overlay;
- Remove all chloride contaminated concrete, or carbonated concrete and patch with an overlay;
- Install cathodic protection to protect the steel reinforcement from further corrosion;
- Use electrochemical chloride extraction (ECE) to remove chloride from the surface of the reinforcing bars and to improve the alkalinity at the bar surface;
- Use re-alkalization to restore the concrete pH; or
- Use corrosion inhibitors on the surface of concrete to reduce the corrosion rate of the embedded reinforcing bars.

After repair is completed, it is important to prevent future deterioration to the structure. Reinforced concrete structures may be protected from corrosive environments by applying a variety of barrier systems between the structure and the corrosive environment. The barrier may be a coating or

membrane applied to the surface of the concrete; formed as an integral part of the concrete matrix through polymer impregnation; or an overlay of polymer concrete, latex-modified concrete, silica-fume concrete, or internally sealed concrete (Chapter 3). ACI 546R provides guidance on the selection and application of materials and techniques for the repair, protection, and strengthening of concrete structures.

The environment may be altered to reduce corrosion either by removing detrimental conditions such as chloride ion, oxygen, and moisture gradients, or by removing or neutralizing stray current sources. Corrosion can also be controlled by modifying the electrochemical reactions at the reinforcing steel, as done in cathodic protection, where the reinforcing steel is made a cathode with respect to an external anode or through application of corrosion inhibitors to the anodic sites.

5.3—Applicability

Nearly all reinforced concrete structures are susceptible to corrosion. Although bridge decks²²¹⁻²²³ are perhaps the most visible examples today, the literature contains many references²²⁴⁻²²⁶ to other types of reinforced-concrete elements that experience corrosion of the reinforcing steel. These include buildings, caissons, foundations, parking garages, piers, piles, pipes, silos, tower footings, and water tanks. Some of these elements may be totally or partially buried in soil. Marine structures, such as offshore platforms, piers and docks; waterfront structures; water and wastewater treatment plants; and water tanks are generally exposed to aqueous solutions. Bridges, parking garages, and buildings are exposed to atmospheric conditions.

If the reinforced concrete structure or element is buried or permanently underwater so that the concrete surfaces are not accessible for treatment and it is impractical to expose them, treating the surfaces is not practical. Similarly, if the element is a buried pipeline or an offshore platform exposed in a large body of water, modifying the environment to make it less corrosive is not practical. Therefore, not all the remedies discussed herein are applicable to all types of reinforced concrete structures in various environments.

Cathodic protection has been used to prevent corrosion of reinforced-concrete structures in corrosive environments. Care should be taken when considering using this system on structures containing prestressing strands due to the risk of hydrogen embrittlement of the prestressing tendons, particularly when impressed-current systems are used.

5.4—The remedies and their limitations

5.4.1 Isolation remedies (barrier systems)—The methods currently used to isolate reinforced concrete structures from corrosive environments include surface coatings and membranes, polymer impregnation, overlays of polymer concrete, low-slump concrete, silica-fume concrete, or latex-modified concrete. These barrier systems are suitable when the surfaces of the concrete structure are available for treatment and they reduce continued intrusion of oxygen, water, and corrosive agents, such as chloride ions, that are required to sustain the corrosion reactions. Barrier systems used after active corrosion is initiated do not stop corrosion, but can

significantly slow down the effects of the corrosion process. If the corrosive agents, particularly chloride ions, are of sufficient quantity, the corrosion process will continue until structural integrity is threatened. Therefore, barrier systems should be considered as only temporary remedies and routine maintenance should be required. Repairs may last 10 to 20 years.²²⁷ All barrier systems will contain discontinuities such as pinholes, breaks, cracks, poor seams, or other defects that will allow intrusion of corrosive agents in localized areas. Nevertheless, barrier systems can substantially reduce the rate of intrusion of corrosive agents and retard the corrosion process. In many cases, these barrier systems successfully extend the useful service life of a structure. For example, a survey of bridges in Virginia showed that latex-modified concrete overlays placed on decks with less than 1.19 kg/m³ (2.0 lb/yd³) of chloride ions at the level of the reinforcing steel can be expected to have a life of more than 20 years.²²⁸

5.4.2 Modification of the environment—Methods available for rendering the environment less corrosive include the removal or elimination of substances and conditions that promote corrosion, such as chlorides, hydrogen sulfide, water, oxygen, and stray electrical currents.

Improving drainage and surface-applied materials, such as silane coatings, will reduce the penetration of water into the concrete. Gases such as oxygen and hydrogen sulfide can be stripped from the electrolyte by chemical processes that are applicable predominantly to structures exposed in aqueous solutions.

Chlorides can be removed from the vicinity of the reinforcing steel by a process known as ECE. The ECE process was investigated as early as 1970s,^{229,230} however, it received detailed attention during the SHRP, resulting in several reports and an implementation guide.²³¹⁻²³³ The process involves placing an anode and electrolyte on the concrete surface and passing a direct current (DC) between the anode and the reinforcing steel, which acts as a cathode. In this electrochemical process, the chloride ions migrate towards the anode, away from the reinforcing steel. The process uses an anode/blanket composite that is placed on the surface of the concrete; the composite is prefabricated and partially reusable. An electrolyte, typically potable water or a calcium hydroxide solution (lime water), is circulated through the system. Calcium hydroxide provides a limited buffering capability, and is used to maintain a basic pH during the process and prevent the etching of concrete and generation of gaseous chlorine. Lithium borate is an expensive electrolyte used only when the structure contains potentially alkali-silica reactive aggregates. The treatment time varies from 10 to 50 days, and the total charge varies from 650 to 1600 A-h/m² (60 to 150 A-h/ft²).

The ECE process removes 20 to 50% of the chlorides present in the concrete. The amount of chlorides removed depends upon several factors, including the amount of chlorides present, its distribution in the concrete, and the details of the steel reinforcement. After the treatment is complete, the chlorides remaining in the structure may be sufficient to reinitiate corrosion. These chlorides, however, are distribut-

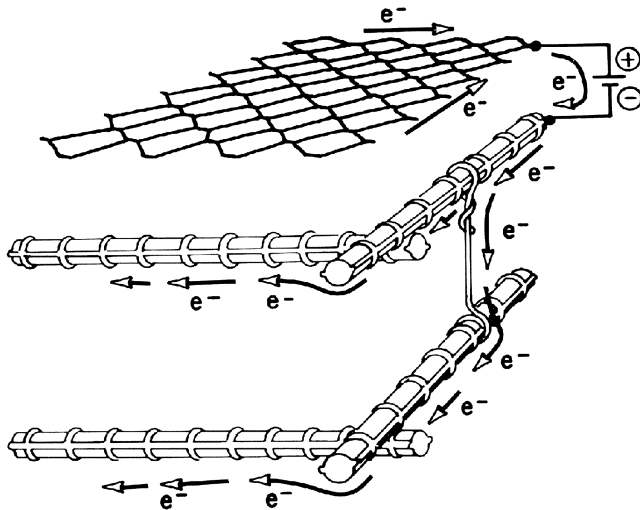

Fig. 5.1—Current flow in a cathodic protection system.

ed well away from the reinforcing steel, and time is required for redistribution to occur. The return to corrosive conditions is further delayed by the buildup of alkalinity at the surface of the reinforcing steel and development of a protective oxide film on the steel surface. Laboratory studies indicate that the ECE process will prevent corrosion for 10 or more years if contamination with new chlorides is prevented. ECE is particularly suited to reinforced concrete structures in which active corrosion is occurring but no significant damage has occurred. The application of ECE is limited to structures with only non-prestressed reinforcement, that is, no prestressing steel.

Deep polymer impregnation²³⁴⁻²³⁶ is another technique for modifying the environment around reinforcing steel. In deep polymer impregnation, an electrically nonconducting material replaces the continuous concrete pore water and stops corrosion. In this process, grooves 19 mm (0.75 in.) wide, 38 mm (1.5 in.) deep, and 75 mm (3.0 in.) on center are cut into the deck surface. The concrete is dried to a depth of 13 mm (0.5 in.) below the concrete surface using propane-fired infrared heaters, and allowed to cool slowly under an insulating mat to ambient temperature. The monomer (methyl methacrylate) is poured into the grooves and allowed to soak into the concrete. Heat is applied to polymerize the monomer in place. The grooves are backfilled with a latex-modified mortar by pouring the mortar on the deck surface and using a squeegee to place it into the grooves. The initial drying of the concrete may cause extensive cracking in the concrete surface. Such polymer treatments are generally considered to be experimental.

Corrosion of reinforcing steel in concrete can be caused by stray current corrosion or other environmental factors in addition to chemicals.²³⁷ Stray current is received by the reinforcing steel embedded in concrete or any metal electrically continuous to the embedded steel and discharged elsewhere on its way to the source. Reinforcing steel corrodes at the point of current discharge. The most common sources of stray currents for reinforced concrete structures include DC-powered electric railways and electroplating plants. This

type of corrosion most commonly occurs in structural elements in contact with the earth. A method of mitigating this type of corrosion, implemented for many years in the buried pipeline industry, is the installation of resistance bonds. In resistance bonding, the structure being affected is electrically connected through a resistor to the source of the stray current. In this manner, the current returns to its source via a metallic path so that the affected structure has no loss of metal. Another method uses galvanic anodes to drain the collected current. Collected current is passed on to the electrolyte (ground water) and back to its source from the surface of the anode. The galvanic anode corrodes, rather than the reinforcing steel. The system must be properly designed, installed, and maintained to ensure that the current discharge electrode is the least resistive path to the source.

5.4.3 Modifying electrochemical reactions at the surface of reinforcing steel—The Pourbaix diagram for iron (Fig. 2.1) shows that steel embedded in concrete is normally passivated due to the highly alkaline concrete environment. The diagram shows another area wherein no steel corrosion occurs. This area, at the lower portion of the diagram, is labeled as “immunity.” In this area, the potential of the steel is more negative than in any naturally occurring condition, regardless of pH.

The method of providing more negative steel potentials required for immunity is referred to as cathodic protection. A 1988-1989 survey indicated that over 275 atmospherically exposed bridge structures in the United States and Canada have been installed with cathodic protection systems.²³⁸ The total cathodically protected concrete surface area was approximately 840,000 m² (9 million ft²). In addition to this there are millions of undocumented square meters of surface area in parking garages.

In cathodically protecting a structure, a favorable electrochemical circuit is established by installing an anode in contact with the electrolyte and passing a low-voltage direct current from that anode through the electrolyte to the reinforcing steel. This current polarizes the surface of the reinforcing steel in the electronegative direction. When this is accomplished, there is no current flow between the formerly anodic and cathodic steel surfaces, and corrosion is arrested. This represents a balanced or equilibrium condition. Figure 5.1 is a schematic representation of current flow in a cathodic protection system.

The protective electrochemical circuit can be established in two ways. One method uses an electrode made of a metal or alloy that is more electronegative than the structure to be protected, such as magnesium, zinc, or aluminum. This method is known as the galvanic anode method of cathodic protection. The galvanic anodes corrode or sacrifice themselves as they pass current to the electrolyte.

There exists some controversy as to which of the various materials will provide the best long-term protection; however, a recent FHWA study²³⁹ found aluminum and zinc anodes to be the most promising galvanic anodes. Some anodes may not provide adequate protection where the concrete has a high resistivity. Anodes should also be sized in accordance

with their respective consumption rates to provide the necessary design life.

Cathodic protection can also be established by inducing an electrical current from an external source. This method is termed impressed current cathodic protection. An impressed current cathodic protection system includes the following basic components:

- DC power source (rectifier);
- Current distribution hardware (anode);
- Conducting electrolyte (concrete);
- Reinforcing steel to be protected (cathode);
- Complete circuit (wiring); and
- Evaluation and control devices (probes, reference cells, controller).

A guide specification has been developed for cathodic protection of concrete bridge decks.²⁴⁰ Similar specifications were developed for bridge substructure cathodic protection under SHRP. The specifications developed under SHRP are included in a manual of practice for cathodic protection of concrete bridges.²⁴¹ Cathodic protection systems included in the manual are briefly described as follows. These systems have performed successfully in the field to varying degrees.

- *Coke-asphalt cathodic protection system:* This system uses anodes of cast-iron alloy, a conductive asphaltic concrete overlay, and a conventional asphaltic concrete wearing surface;
- *Slotted-cathodic protection system:* This system involves the insertion of an anode system, such as catalyzed titanium ribbon mesh, into slots cut into the concrete surface. The slots are then backfilled with a nonshrink, cementitious grout;
- *Distributed-anode cathodic protection system with concrete overlays:* This system involves placing anodes on the concrete surface after repairs and cleaning, followed by encapsulation of the anodes in concrete. Encapsulation may consist of an overlay on horizontal surfaces or cast-in-place shotcrete on vertical surfaces. Anodes of catalyzed titanium mesh anodes are the most common;
- *Conductive coating:* This system uses platinized wire and conductive carbon-based paints to cover the entire surface to be protected. This system is primarily used on nontraffic surfaces that are not exposed to continuous wetting during either construction or in service; and
- *Sprayed zinc:* In this system, molten zinc is sprayed onto the entire concrete surface using arc-spray or flame-spray equipment. The zinc coating can be used as a galvanic anode or as an impressed current anode if electrically isolated from the steel.

Whether a structure is a candidate for cathodic protection depends on several factors. The characteristics of a good candidate for cathodic protection are:

- Delaminated areas of less than 5%;
- Large percentage of potentials more negative than -350 mV CSE;
- An entrained air content of the concrete of at least 5%;
- Acid-soluble chloride ion contents of more than 0.20% by mass of cement at the level of reinforcing steel; and

- Concrete cover greater than 13 mm (0.5 in.).

Also, the majority of reinforcing steel in the structure should be electrically continuous, and the structure should be close to a source of electrical power if impressed current cathodic protection is being considered.

Various parameters have to be considered to estimate the required currents for impressed current cathodic protection. These parameters include the surface area of the concrete to be protected, size and spacing of reinforcing bars, and current density. The rectifier size is selected based upon the current requirement. Cathodic protection anodes are usually segmented into zones that permit greater flexibility in control and facilitate trouble-shooting in problem areas. Large zones can lead to problems such as undersupply or oversupply of the current to particular areas of the structure. Each zone typically requires a separate rectifier control circuit and power feed from the rectifier to the anode and system ground. Typical zone sizes range from 1500 to 2100 m² (5000 to 7000 ft²). On bridges, the location and frequency of the expansion joints may determine the sizes of the zones.

The voltage drop and current attenuation along the anode and its connecting wire in the cathodic protection system should be evaluated. If the voltage drops are excessive, uneven and insufficient current distribution to the reinforcing steel may result. For even current distribution to a structure, the voltage drop should not exceed 300 mV from the current feed point to the farthest point in the anode circuit. The design should therefore optimize anode system length, anode spacing and size, and conductor size to achieve safe and efficient current distribution.

Redundancy of current output, circuitry, and monitoring devices (reference cells and probes) should be provided to minimize the area affected by malfunction or physical damage. The rectifier should be selected to provide adequate allowance for anticipated changes in current requirement with time. The design output voltage should take into account the voltage required to drive the cathodic protection current from the anode to the reinforcing steel, the voltage loss in the positive and negative DC wiring, and should include a safety factor of 100 to 200% to accommodate future current demands.

Various criteria have been established to ensure adequate cathodic protection of reinforcing steel. The 100 mV depolarization criterion is most commonly used. It is based on the theory that polarization of corroding reinforcing steel in the cathodic direction will inhibit anodic (corrosion) reactions. Polarization is usually estimated by measuring the polarization decay of the reinforcing steel that occurs after the protective current is turned off. Steel potentials, measured using half-cells, are plotted against time over a minimum four-hour test period. If a 100 mV or greater polarization shift is measured, then the level of protection is judged sufficient to stop corrosion.

Another criterion is the *E-Log I* test performed by incrementally increasing the cathodic protection current and measuring the change in potential of the reinforcing steel. A plot of the potential versus the logarithm of the current is called the *E-Log I* plot. The current required for cathodic protection is the value that occurs at the beginning of the linear portion

of the plot. The technique often requires special power supplies and instrumentation and it is difficult, time consuming, and relatively complicated to analyze.

Two new criteria were developed under SHRP²⁴²—the corrosion null probe and constant current; however, these are seldom used due to difficulties in measurement.

After completing the initial inspection, the cathodic protection system should be adjusted for current requirements. After adjustment, the system should be operated continuously for a period of at least 1 month before conducting final acceptance testing. As a minimum, the rectifier voltage and current should be measured monthly for the first year and quarterly thereafter. Records should include a permanent log of the system output. Annual surveys should also be conducted to verify that the cathodic protection system is meeting protection criteria. The system should be adjusted and repaired as necessary to ensure continued, effective protection.

5.5—Summary

Remedies for controlling corrosion on existing reinforced-concrete structures use sound corrosion engineering principles directed at isolating the reinforced concrete from the corrosive environment, alteration of the environment, or control of electrical current flow within the environment. Corrosive agents are already present within the concrete matrix when corrosion is detected in a reinforced concrete member. Though measures that isolate concrete minimize the rate of corrosion or the intrusion of additional corrosive agent, they trap the existing quantities of these corrosive agents. The effectiveness of isolation measures can be improved by removal of corrosive agents before sealing, such as by electrochemical chloride extraction. Several of the proposed remedies are in the development stage. Such approaches as deep-polymer impregnation and corrosion inhibitors have not been proven as practicable methods of corrosion control on existing reinforced concrete structures.

Various remedial measures have been proven to be capable of controlling corrosion on an existing structure. Criteria and guidelines have been established for the selection, design, construction, and operation of these systems for the protection of reinforcing steel in atmospherically exposed concrete structures.

CHAPTER 6—REFERENCES

6.1—Referenced standards and reports

The standards and reports listed as follows were the latest editions at the time this document was prepared. Because these documents are revised frequently, the reader is advised to contact the proper sponsoring group if it is desired to refer to the latest version.

American Association of State Highway and Transportation Officials (AASHTO)

T24 Standard Method of Test for Obtaining and Testing Drilled Cores and Sawed Beams of Concrete

T260 Standard Method of Test for Sampling and Testing for Chloride Ion in Concrete and Concrete Raw Materials

T277 Standard Method of Test for Electrical Indication of Concrete's Ability to Resist Chloride Ion Penetration

TP-36 Standard Test Method for Evaluating Asphalt-Covered Concrete Bridge Decks Using Pulsed Radar

American Concrete Institute (ACI)

201.2R Guide to Durable Concrete

222.1 Provisional Standard Test Method for Water Soluble Chloride Available for Corrosion of Embedded Steel in Mortar and Concrete Using the Soxhlet Extractor

224R Control of Cracking in Concrete Structures

228.2R Nondestructive Test Methods for Evaluation of Concrete in Structures

318R Building Code Requirements for Structural Concrete

423.4R Corrosion and Repair of Unbonded Single Strand Tendons

546R Concrete Repair Guide

548.1R Guide for the Use of Polymers in Concrete

548.3R State-of-the-Art Report on Polymer-Modified Concrete

548.4 Standard Specification for Latex-Modified Concrete (LMC) Overlays

American Society for Testing and Materials (ASTM)

A 775/A 775 M Standard Specification for Epoxy-Coated Reinforcing Steel Bars

C 42 Standard Test Method for Obtaining and Testing Drilled Cores and Sawed Beams of Concrete

C 597 Standard Test Method for Pulse Velocity through Concrete

C 856 Standard Practice for Petrographic Examination of Hardened Concrete

C 876 Standard Test Method for Half-Cell Potentials of Uncoated Reinforcing Steel in Concrete

C 1152 Standard Test Method for Acid-Soluble Chloride in Mortar and Concrete

C 1202 Standard Test Method for Electrical Indication of Concrete's Ability to Resist Chloride Ion Penetration

C 1218 Standard Test Method for Water-Soluble Chloride in Mortar and Concrete

C 1383 Standard Test Method for Measuring the P-wave Speed and the Thickness of Concrete Plates Using the Impact-Echo Method

- D 4580 Standard Practice for Measuring Delaminations in Concrete Bridge Decks by Sounding
- D 4788 Standard Test Method for Detecting Delaminations in Bridge Decks Using Infrared Thermography
- D 5385 Standard Test Method for Hydrostatic Pressure Resistance of Waterproofing Membranes
- D 6087 Standard Test Method for Evaluating Asphalt-Covered Concrete Bridge Decks Using Ground Penetrating Radar
- G 57 Standard Test Method for Field Measurement of Soil Resistivity Using the Wenner Four-Electrode Method

British Code

- CP 110 Code of Practice for Structural Use of Concrete

Norwegian Building Code

- NS 3420-L Betong/Specification Texts for Building, Construction, Installations—Part L: Concrete (*in Norwegian*)

These publications may be obtained from the these organizations:

American Concrete Institute
P.O. Box 9094
Farmington Hills, MI 48333-9094

ASTM
100 Barr Harbor Drive
West Conshohocken, PA 19428

British Standards Institution
2 Park Street
London W1A 2BS
United Kingdom

Norwegian Standards Association
Postboks 7020 Homansbyen
N-0306 Oslo 3
Norway

6.2—Cited references

1. Tremper, B.; Beaton, J. L.; and Stratfull, R. F., "Causes and Repair of Deterioration to a California Bridge due to Corrosion of Reinforcing Steel in a Marine Environment. II: Fundamental Factors Causing Corrosion," *Bulletin No. 182*, Highway Research Board, Washington, D.C., 1958, pp. 18-41.
2. Evans, U. R., *The Corrosion and Oxidation of Metals: Scientific Principles and Practical Applications*, Edward Arnold, London, 1960, 303 pp.
3. Biczók, I., *Concrete Corrosion and Concrete Protection*, 3rd Edition, Akadémiai Kiadó, Budapest, 1964.
4. McDonald, D. B.; Sherman, M. R.; Pfeifer, D. W.; and Virmani, Y. P., "Stainless Steel Reinforcement as Corrosion

Protection," *Concrete International*, V. 17, No. 5, May 1995, pp. 65-70.

5. Pourbaix, M., "Atlas of Electrochemical Equilibria in Aqueous Solutions," National Association of Corrosion Engineers (NACE), Houston, Tex., 1974.

6. Townsend, H. E., "Potential—pH Diagrams at Elevated Temperature for the System Fe-H₂," *Proceedings of the Fourth International Congress on Metallic Corrosion*, Sept. 1969, pp. 477-487.

7. Foley, R. T., "Complex Ions and Corrosion," *Journal of the Electrochemical Society*, V. 122, No. 11, 1975, pp. 1493-1549.

8. Uhlig, H. H., *Corrosion and Corrosion Control*, 2nd Edition, John Wiley & Sons, Inc., New York, 1971, 419 pp.

9. Al-Tayyib, A. J., and Khan, M. S., "Corrosion Rate Measurements of Reinforcing Steel in Concrete by Electrochemical Techniques," *ACI Materials Journal*, V. 85, No. 3, May-June 1988, pp. 172-177.

10. Andrade, C., and Gonzalez, J. A., "Quantitative Measurements of Corrosion Rate of Reinforcing Steels Embedded in Concrete Using Polarization Resistance Measurements," *Werkstoffe und Korrosion*, V. 29, 1978, pp. 515.

11. Mansfeld, F., "Recording and Analysis of AC Impedance Data for Corrosion Studies," *Corrosion*, V. 37, No. 5, 1981, pp. 301-307.

12. Young, J. F., "A Review of the Pore Structure of Cement Paste and Concrete and its Influence on Permeability," *Permeability of Concrete*, SP-108, D. Whiting and A. Walitt, eds., American Concrete Institute, Farmington Hills, Mich., 1988, pp. 1-18.

13. Browne, R. D., "Mechanisms of Corrosion of Steel in Concrete in Relation to Design, Inspection, and Repair of Off-shore and Coastal Structures," *Performance of Concrete in Marine Environment*, SP-65, V. M. Malhotra, ed., American Concrete Institute, Farmington Hills, Mich., 1980, pp. 169-204.

14. Short, N. R., and Page, C. L., "The Diffusion of Chloride Ions through Portland and Blended Cement Pastes," *Silicates Industries*, V. 10, 1982, pp. 237-240.

15. Mehta, P. K., "Durability of Concrete Exposed to Marine Environment—A Fresh Look," *Concrete in Marine Environment*, SP-109, 1994, V. M. Malhotra, ed., American Concrete Institute, Farmington Hills, Mich., 1989, pp. 1-29.

16. Page, C. L.; Short, N. R.; and El Tarras, A., "Diffusion of Chloride Ions in Hardened Cement Pastes," *Cement and Concrete Research*, V. 11, No. 3, 1981, pp. 395-406.

17. Goto, S., and Roy, D. M., "Diffusion of Ions through Hardened Cement Pastes," *Cement and Concrete Research*, V. 11, No. 5/6, 1981, pp. 751-757.

18. Schonlin, K., and Hilsdorf, H. K., "Permeability as a Measure of Potential Durability of Concrete—Development of a Suitable Apparatus," *Permeability of Concrete*, SP-108, D. Whiting and A. Walitt, eds., American Concrete Institute, Farmington Hills, Mich., 1988, pp. 99-116.

19. Midgley, H. G., and Illston, J. M., "The Penetration of Chlorides into Hydrated Cement Paste," *Cement and Concrete Research*, V. 14, 1984, pp. 546-558.

20. Bentz, E. C.; Evans, C. M.; and Thomas, M. D. A., "Chloride Diffusion Modeling for Marine Exposed Concrete," *Fourth International Symposium on Corrosion of Re-*

inforcement in Concrete Construction, SCI, Cambridge, UK, 1996, pp. 136-145.

21. Page, C. L.; Short, N. R.; and Holdon, W. R., "The Influence of Different Cements on Chloride-Induced Corrosion of Reinforcing Steel," *Cement and Concrete Research*, V. 16, No. 1, 1986, pp. 79-86.

22. Escalante, E.; Ito, S.; and Cohen, M., "Measuring the Rate of Corrosion in Reinforcing Steel in Concrete," *NBSIR 80-2012*, NIST, Washington, DC, 1980.

23. Hansson, C. M., and Sorensen, B., "The Threshold Concentration of Chloride in Concrete for the Initiation of Reinforcement Corrosion," *Corrosion Rates of Steel in Concrete*, ASTM STP 1065, N. S. Berke, V. Chaker, and D. Whiting, eds., American Society for Testing and Materials, West Conshohocken, Pa., 1990, pp. 3-16.

24. Clear, K. C., "Time-to-Corrosion for Reinforcing Steel in Concrete Slabs. V. 3: Performance After 830 Daily Salt Applications," FHWA-RD-76-70, Federal Highway Administration, Washington D.C., Apr., 1976, 64 pp.

25. *CEB Design Guide for Durable Concrete Structures*, 2nd Edition, 1992, Thomas Telford Publishers.

26. Diamond, S., "Chloride Concentrations in Concrete Pore Solutions Resulting From Calcium and Sodium Chloride Admixtures," *Cement, Concrete, and Aggregates*, V. 8, No. 2, 1986, 97 pp.

27. Goni, S., and Andrade, C., "Synthetic Concrete Pore Solution Chemistry and Rebar Corrosion Rate in the Presence of Chlorides," *Cement and Concrete Research*, V. 20, No. 4, 1990, pp. 525-539.

28. Page, C. L.; Short, N. R.; and Holden, W. R., "The Influence of Different Cements on Chloride-Induced Corrosion of Reinforcing Steel," *Cement and Concrete Research*, V. 16, 1986, pp. 79.

28. Rasheeduzzafar, "Influence of Cement Composition on Concrete Durability," *ACI Materials Journal*, V. 89, No. 6, Nov.-Dec., 1992, pp. 574-586.

29. Roberts, M. H., "Carbonation of Concrete Made with Dense Natural Aggregates," *Publication Ip6/81*, Building Research Establishment, Garston, UK, Apr. 1981.

30. Adolf, M., "Investigations of the Carbonation of Concrete," *Supplementary Paper III-52*, 5th International Symposium on Chemistry of Cement, Tokyo, 1968, pp. 394-401.

31. Schiesel, P., "Corrosion of Reinforcement," *Durability of Concrete Structures*, CEB-Rilem International Workshop, Copenhagen, 1983, pp. 73-93.

32. Pfeifer, D. W., and Scali, M. J., "Southern Climate Accelerated Test Method," *NCHRP Report No. 244*, National Cooperative Highway Research Project, Transportation Research Board, National Research Council, Washington D.C., 1981.

33. Tuutti, K., "Corrosion of Steel in Concrete," Swedish Cement and Concrete Research Institute, Stockholm, No. 4, 1982, 469 pp.

34. Beeby, A. W., "Cracking, Cover, and Corrosion of Reinforcement," *Concrete International*, V. 5, No. 2, Feb. 1983, pp. 35-40.

35. Gouda, V. K., and Monfore, G. E., "A Rapid Method for Studying the Corrosion Inhibition of Steel in Concrete,"

Journal of the Portland Cement Association: Research and Development Laboratories, V. 7, 1965, pp. 2431.

36. Mehta, P. K., "Durability of Concrete in Marine Environment—A Review," *Performance of Concrete in Marine Environment*, SP-65, V. M. Malhotra, ed., American Concrete Institute, Farmington Hills, Mich., 1980, pp. 1-20.

37. SHRP Project C-343, "Eliminating or Minimizing Alkali Silica Reactivity," National Research Council, Washington D.C., 1993.

38. Gjorv, O. E.; Vennesland, O.; and El-Busaidy, A. H. S., "Diffusion of Dissolved Oxygen through Concrete," No. 17, *NACE Corrosion 76*, National Association of Corrosion Engineers, Houston, Tex., 1976, 13 pp.

39. "Influence of Design and Materials on Corrosion Resistance of Steel in Concrete," *PCA Report RD-098*, Portland Cement Association, Skokie, Ill. A 775/A 775M, 1989.

40. "Standard Specification for Epoxy-Coated Reinforcing Bars," American Association of State and Highway and Transportation Officials, Designation M 284/M 284M.

41. Bentur, A.; Diamond, S.; and Berke, N. S., 1997, *Steel Corrosion in Concrete*, E & FN Spon, London, 1997, pp. 136-139.

42. Samples, L. M., and Ramirez, J. A., *Field Investigations of Existing and New Construction Concrete Bridge Decks*, Research Series 6, Concrete Reinforcing Steel Institute, Schaumburg, Ill., 1999.

43. Virmani, P., "Corrosion Evaluation of Epoxy Coated, Metallic Clad, and Solid Metallic Reinforcing Bars in Concrete," FHWA-RD-98-153.

44. Manning, D. G., "Corrosion Performance of Epoxy-Coated Reinforcing Steel: North American Experience," *Construction and Building Materials*, V. 10, No. 5, 1996, pp. 349-365.

45. Sagues, A. A., and Zayed, A. M., "Corrosion of Epoxy-Coated Reinforcing Steel in Concrete—Phase I and II," South Florida University for the Florida Department of Transportation and Federal Highway Administration, 1989.

46. McDonald, D. B.; Pfeifer, D. W.; and Sherman, M. R., "Corrosion Evaluation of Epoxy-Coated, Metallic Clad and Solid Metallic Reinforcing Bars in Concrete," *Report No. FHWA RD-98-153*, Federal Highway Administration, Washington D.C., Dec. 1998.

47. McDonald, D. B., and Pfeifer, D. W., "Epoxy-Coated Bars—State-of-the-Art," *Proceedings of the Second Regional Conference and Exhibition*, ASTM, Saudi Arabian Section, V. 2, Nov. 1995.

48. Boyd, W. K., and Tripler, A. B., "Corrosion of Reinforced Steel Bars in Concrete," *Materials Protection*, V. 7, No. 10, 1968, pp. 40-47.

49. Sykes, J. M., "Electrochemical Studies on Steel in Concrete," *Materials Science Forum*, 1995, pp. 192-194.

50. Scali, M. J.; Chin, D.; and Berke, N. S., "Effect of Silica Fume and Fly Ash Upon the Microstructure and Permeability of Concrete," *Proceedings of the 9th International Conference on Cement Microscopy*, International Cement Microscopy Association, Duncanville, Tex., 1987, pp. 375-397.

51. Mehta, P. K., "Effect of Cement Composition on Corrosion of Reinforcing Steel in Concrete," *Chloride Corro-*

sion of Steel in Concrete, STP 629, ASTM, West Conshohocken, Pa., 1977, pp. 12-19.

52. Ozyildirim, C., "Laboratory Investigation of Concrete Containing Silica Fume for Use in Overlays," *ACI Materials Journal*, V. 84, No. 1, Jan.-Feb. 1987, pp. 3-7.

53. Sellevold, E. J.; Bager, D. H.; Jensen, E. K.; and Knudsen, T., "Silica Fume Cement Paste—Hydration and Pore Structure," *Condensed Silica Fume in Concrete*, V. 15, No. 6, Nov. 1985, pp. 1027-1038.

54. Feldman, R. F., "Pore Structure Formation During Hydration of Fly Ash and Slag Cement Blends," *Effects of Fly Ash Incorporation in Cement and Concrete*, S. Diamond, ed., Materials Research Society, Pittsburgh, Pa., 1981, pp. 124-133.

55. Marsh, K.; Day, R. L.; and Bonner, D. G., "Pore Structure Characteristics Affecting the Permeability of Cement Paste Containing Fly Ash," *Cement and Concrete Research*, V. 15, No. 6, Nov. 1985, pp. 1027-1038.

56. Berke, N. S., and Weil, T. G., "World Wide Review of Corrosion Inhibitors in Concrete," *Advances in Concrete Technology*, CANMET, Montreal, 1992, pp. 899-924.

57. Craig, R. J., and Wood, L. E., "Effectiveness of Corrosion Inhibitors and Their Influence on the Physical Properties of Portland Cement Mortars," *Highway Research Record* No. 328, Highway Research Board, 1970, pp. 77-88.

58. Nmai, C. K.; Farrington, S. A.; and Bobrowski, G. S., "Organic-Based Corrosion-Inhibiting Admixture for Reinforced Concrete," *Concrete International*, V. 14, No. 4, Apr. 1992, pp. 45-51.

59. Treadway, K. W. J., and Russell, A. D., "Inhibition of the Corrosion of Steel in Concrete," *Highways and Public Works*, V. 36, No. 1704, Aug. 1968, pp. 19-21.

60. Berke, N. S., and El-Jazairi, B., "The Use of Calcium Nitrite as a Corrosion Inhibiting Admixture to Steel Reinforcement in Concrete," *Corrosion of Reinforcement in Concrete*, Elsevier Applied Science, London, 1990, pp. 571-585.

61. Tomosawa, F.; Masuda, Y.; Fukushi, I.; Takakura, M.; and Hori, T., "Experimental Study on the Effectiveness of Corrosion Inhibitors in Reinforced Concrete," *Admixtures for Concrete: Improvement of Properties*, Proceedings of the RILEM International Durability Symposium, Barcelona, 1990, pp. 382-391.

62. Berke, N. S.; Hicks, M. C.; and Hoopes, R. J., "Condition Assessment of Field Structures with Calcium Nitrite," *Concrete Bridges in Aggressive Environments*, Philip D. Cady International Symposium, SP-151, R. E. Weyers, ed., American Concrete Institute, Farmington Hills, Mich., 1994, pp. 43-72.

63. "Durability of Concrete Bridge Decks," *NCHRP Synthesis* No. 57, Transportation Research Board Washington, D.C., 1979, 60 pp.

64. ACI Committee 201, "Guide to Durable Concrete (ACI 201.2R-77) (Reapproved 1982)," American Concrete Institute, Farmington Hills, Mich., 1977, 37 pp.

65. Beaton, J. L., and Stratfull, R. F., "Environmental Influence on Corrosion of Reinforcing in Concrete Bridge Substructures," *Highway Research Record* No. 14, Highway Research Board, 1963, pp. 60-78.

66. Ost, B., and Monfore, G. E., "Penetration of Chloride into Concrete," *Journal, PCA Research and Development Laboratories*, V. 8, No. 1, Jan. 1966, pp. 46-52.

67. Clear, K. C., "Time-to-Corrosion of Reinforcing Steel in Concrete Slabs, V. 3: Performance after 830 Daily Salt Applications," *Report No. FHWA-RD-76-70*, Federal Highway Administration, Washington, D.C., 1976, 64 pp.

68. Stark, D., "Studies of the Relationships between Crack Patterns, Cover over Reinforcing Steel and the Development of Surface Spalls in Bridge Decks," *Special Report* No. 116, Highway Research Board, Washington, D.C., 1971, pp. 13-21.

69. Pfeifer, D. W.; Landgren, J. L.; and Zoob, A., "Protective Systems for New Prestressed and Substructure Concrete," *Report No. FHWA/Rd-86/193*, Federal Highway Administration, Washington, D.C., 1987, 121 pp.

70. Cornet, I., "Protection with Mortar Coatings," *Materials Protection*, V. 6, No. 3, 1967, pp. 56-58.

71. Atimay, E., and Ferguson, P. M., "Early Chloride Corrosion of Reinforced Concrete—A Test Report," *Materials Performance*, V. 13, No. 12, 1974, pp. 18-21.

72. Gjordv, O. E.; Vennesland, O.; and El-Busaidy, A. H. S., "Diffusion of Dissolved Oxygen through Concrete," *Paper* No. 17, NACE Corrosion 76, National Association of Corrosion Engineers, Houston, Tex., Mar. 1976, 13 pp.

73. Haynes, H. H., "Permeability of Concrete in Sea Water," *Performance of Concrete in Marine Environment*, SP-65, V. M. Malhotra, ed., American Concrete Institute, Farmington Hills, Mich., 1980, pp. 21-38.

74. Hime, W. D., and Erlin, B., "Chloride Free Concrete," *ACI JOURNAL, Proceedings* V. 74, No. 10, Oct. 1977, p. N7.

75. Lewis, D. A., "Some Aspects of the Corrosion of Steel in Concrete," *Proceedings*, 1st International Congress on Metallic Corrosion, Butterworths, London, 1962, pp. 547-552.

76. Gouda, V. K., "Corrosion and Corrosion Inhibition of Reinforcing Steel I: Immersed in Alkaline Solutions," *British Corrosion Journal* (London), V. 5, 1970, pp. 198-203.

77. Arup, H., "Recent Progress Concerning Electrochemistry and Corrosion of Steel in Concrete," *ARBEM Symposium*, Paris, Oct. 1982.

78. Stratfull, R. F.; Jurkovich, W. J.; and Spellman, D. L., "Corrosion Testing of Bridge Decks," *Transportation Research Record* No. 539, Transportation Research Board, 1975, pp. 50-59.

79. Chamberlin, W. P.; Irwin, R. J.; and Amsler, D. E., "Waterproofing Membranes for Bridge Deck Rehabilitation," *Research Report* No. 52 (FHWA-NY-77-59-1), New York State Department of Transportation/ Federal Highway Administration, Washington, D.C., 1977, 43 pp.

80. Rogers, C., and Woda, G., "The Chloride Ion Content of Concrete Aggregate from Southern Ontario," *Report* No. EM-17, Ontario Ministry of Transportation and Communications, Downsview, 1977.

81. Roberts, M. H., "Effect of Calcium Chloride on the Durability of Pretensioned Wire in Prestressed Concrete," *Magazine of Concrete Research* (London), V. 14, No. 42, Nov. 1962, pp. 143-154.

82. Locke, C. E., and Siman, A., "Electrochemistry of Reinforcing Steel in Salt-Contaminated Concrete," *Corrosion*

of Reinforcing Steel in Concrete, STP-713, ASTM, West Conshohocken, Pa., 1980, pp. 3-16.

83. Browne, R. D., "Mechanisms of Corrosion of Steel in Concrete in Relation to Design, Inspection, and Repair of Offshore and Coastal Structures," *Performance of Concrete in Marine Environment*, SP-65, V. M. Malhotra, ed., American Concrete Institute, Farmington Hills, Mich., 1980, pp. 169-204.

84. Diamond, S., and Lopez-Flores, F., "Fate of Calcium Chloride Dissolved in Concrete Mix Water," *Journal, American Ceramic Society*, V. 64, No. 11, Nov. 1981, pp. C 162-164.

85. "The Role of Calcium Chloride in Concrete," *Concrete Construction*, V. 21, No. 2, Feb. 1976, pp. 57-61.

86. Cornet, I., "Corrosion of Prestressed Concrete Tanks," *Materials Protection*, V. 3, No. 1, Jan. 1964, pp. 9-100.

87. Hope, B. B., and Ip, A. K. C., "Chloride Corrosion Threshold in Concrete," *ACI Materials Journal*, V. 84, No. 4, July-Aug. 1987, pp. 306-314.

88. Peterson, C. A., "Survey of Parking Structure Deterioration and Distress," *Concrete International*, V. 2, No. 3, Mar. 1980, pp. 53-61.

89. Monfore, G. E., and Verbeck, G. J., "Corrosion of Prestressed Wire in Concrete," *ACI JOURNAL, Proceedings* V. 57, No. 5, Nov. 1960, pp. 491-516.

90. Hope, B. B.; Page, J. A.; and Poland, J. S., "The Determination of the Chloride Content of Concrete," *Cement and Concrete Research*, V.15, No. 5, Sept. 1985, pp. 863-870.

91. Stratfull, R. F., ed., *A Manual for the Corrosion Control of Bridge Decks*, Contract No. DTFH-61-C-00016, U.S. Department of Transportation, Washington, D.C.

92. "Conduit in Concrete," *Engineering Journal* (Montreal), V. 38, No. 10, 1955, pp. 1357-1362.

93. "Spalled Concrete Traced to Conduit," *Engineering News-Record*, V. 172, No. 11, Mar. 1964, pp. 28-29.

94. McGeary, F. L., "Performance of Aluminum in Concrete Containing Chlorides," *ACI JOURNAL, Proceedings* V. 63, No. 2, Feb. 1966, pp. 247-266.

95. Erlin, B., and Woods, H., "Corrosion of Embedded Materials Other than Reinforcing Steel," *Significance of Tests and Properties of Concrete and Concrete-Making Materials*, STP-169B, ASTM, West Conshohocken, Pa., 1978, pp. 300-319.

96. Manning, D. G., "Corrosion Resistant Design of Concrete Structures," *Proceedings*, Canadian Structural Concrete Conference, University of Toronto, 1981, pp. 199-223.

97. Beeby, A. W., "Corrosion of Reinforcing Steel in Concrete in Its Relation to Cracking," *The Structural Engineer* (London), V. 56A, No. 3, 1978, pp. 77-81.

98. Tremper, B., "The Corrosion of Reinforcing Steel in Cracked Concrete," *ACI JOURNAL, Proceedings* V. 43, No. 10, June 1947, pp. 1137-1144.

99. Martin, H., and Schiessl, P., "The Influence of Cracks on the Corrosion of Steel in Concrete," *Preliminary Report*, RILEM International Symposium on the Durability of Concrete, Prague, V. 2., 1969.

100. Raphael, M., and Shalon, R., "A Study of the Influence of Climate on Corrosion of Reinforcement," *Proceedings*, RILEM Symposium on Concrete and Reinforced

Concrete in Hot Countries, Building Research Station, Haifa, 1971, pp. 77-96.

101. Schiessl, P., and Raupach, M., "Laboratory Studies and Calculations on the Influence of Crack Widths on Chloride-Induced Corrosion of Steel in Concrete," *ACI Materials Journal*, V. 94, No. 1, Jan.-Feb. 1997, pp. 56-62.

102. Beeby, A. W., "Concrete in the Oceans—Cracking and Corrosion," *Technical Report* No. 1, CIRIA/UEG, Construction Industry Research and Information Association/Department of Energy, London, 1978.

103. Manning, D. G., and Ryell, J., "Durable Bridge Decks," *Report* No. RR203, Ontario Ministry of Transportation and Communications, Downsview, 1976, 67 pp.

104. Boulware, R. L., and Elliott, A. L., "California Seals Salt-Damaged Bridge Decks," *Civil Engineering-ASCE*, V. 41, No. 10, Oct. 1971, pp. 42-44.

105. Van Til, C. J.; Carr, B. J.; and Vallerga, B. A., "Waterproof Membranes for Protection of Concrete Bridge Decks: Laboratory Phase," *NCHRP Report* No. 165, Transportation Research Board, Washington, D.C., 1976, 70 pp.

106. Frascoia, R. I., "Vermont's Experience with Bridge Deck Protective Systems," *Chloride Corrosion of Steel in Concrete*, STP-629, ASTM, West Conshohocken, Pa., 1977, pp. 69-81.

107. Spellman, D. L., and Stratfull, R. F., "Bridge Deck Membranes—Evaluation and Use in California," *Report* No. CA-DOT-TL-5116-9 73-38, California Department of Transportation, Sacramento, Calif., 1973.

108. Frascoia, R.I., "Evaluation of Bridge Deck Membrane Systems and Membrane Evaluation Procedures," *Report* No. 77-2, Vermont Department of Highways, Montpelier, 1977.

109. Corkill, J. T., "A Field Study of the Performance of Bridge Deck Waterproofing Systems in Ontario," *Proceedings*, 1975 Annual Conference, Roads and Transportation Association of Canada, V. 2, 1975, pp. 79-100.

110. "Membrane Waterproofing for Bridge Decks," *Final Report*, Oregon Department of Transportation, Salem, 1977.

111. MacDonald, M. D., "Waterproofing Concrete Bridge Decks: Materials and Methods," *TRRL Report* No. LR636, Transport and Road Research Laboratory, Crowthorne, Berkshire, 1974, 32 pp.

112. Legvold, T. L., "Bridge Deck Waterproofing Membrane Study," *Report* No. R-262, Iowa State Highway Commission, Ames, Iowa, 1974.

113. Meader, A. L., Jr.; Schmitz, C. G.; and Henry, J. E., "Development of a Cold-Poured Bridge Deck Membrane System," *Chloride Corrosion of Steel in Concrete*, STP-629, ASTM, West Conshohocken, Pa., 1977, pp. 164-177.

114. Steinberg, M.; Dikeou, J. T.; Kukacka, L. E.; Backstrom, J. E.; Colombo, P.; Rubenstein, S.; Kelsch, J. J.; and Manowitz, B., "Concrete-Polymer Materials—First Topical Report," BNL 50134 (T-509) and *USBR General Report* No. 41, Brookhaven National Laboratory/U.S. Bureau of Reclamation, Denver, Colo., Dec. 1968, 83 pp.

115. Smoak, W. G., "Development and Field Evaluation of a Technique for Polymer Impregnation of New Concrete

Bridge Deck Surfaces," *Report No. FHWA-RD-76-95*, Federal Highway Administration, Washington, D.C., 1976.

116. Fowler, D. W., "Current Status of Polymers in Concrete," *Proceedings of the 5th International Congress on Polymers in Concrete*, Brighton, England, Sept. 1987, pp. 3-7.

117. Krauss, P. D., "Status of Polyester-Styrene Resin Concrete Bridge Deck and Highway Overlays in California," *Proceedings*, 43rd Annual Conference, The Society of the Plastics Industry, Inc., Composites Institute, Cincinnati, Ohio, Feb. 1988.

118. McConnell, W. R., "Epoxy Surface Treatments for Portland Cement Concrete Pavements," *Epoxyes with Concrete*, SP-21, J. D. Kriegen, ed., American Concrete Institute, Farmington Hills, Mich., 1968, pp. 9-17.

119. Santucci, L. E., "Polyester Overlays for Portland Cement Concrete Surfaces," *Highway Research Record No. 14*, Highway Research Board, 1963, pp. 44-56.

120. Jenkins, J. C.; Beecroft, G. W.; and Quinn, W. J., "Polymer Concrete Overlays: Interim Users Manual," *Report No. FHWA-TS-78-218*, Federal Highway Administration, Washington, D.C., 1977.

121. Sprinkel, M. M., "Performance of Multiple Layer Polymer Concrete Overlays on Bridge Decks," *Polymers in Concrete: Advances and Applications*, SP-116, P. Mendis and C. McClaskry, eds., American Concrete Institute, Farmington Hills, Mich., 1989, pp. 61-95.

122. Tremper, B., "Repair of Damaged Concrete with Epoxy Resins," *ACI JOURNAL, Proceedings V. 57*, No. 2, Aug. 1960, pp. 173-182.

123. Felt, E. J., "Resurfacing and Patching Concrete Pavements with Bonded Concrete," *Proceedings*, Highway Research Board, V. 35, 1956, pp. 444-469.

124. Westall, W. G., 1960, "Bonded Resurfacing and Repairs of Concrete Pavements," *Bulletin No. 260*, Highway Research Board, Washington, D.C., pp. 14-24.

125. McKeel, W. T., Jr.; and Tyson, S. S., "Two-Course Bonded Construction and Overlays," *ACI JOURNAL, Proceedings V. 72*, No. 12, Dec. 1975, pp. 708-713.

126. Clear, K. C., and Forster, S. W., "Internally Sealed Concrete: Material Characterization and Heat Treating Studies," *Report No. FHWA-RD-77-16*, Federal Highway Administration, Washington, D.C., 1977, 73 pp.

127. Cardone, S. M.; Brown, M. G.; and Hill, A. A., "Latex-Modified Mortar in the Restoration of Bridge Structures," *Bulletin No. 260*, Highway Research Board, Washington, D.C., 1960, pp. 1-13.

128. Bishara, A. G., "Latex Modified Concrete Bridge Deck Overlays, Field Performance Analysis," *Report No. ODOT 2895*, Ohio Department of Transportation, Columbus, Ohio, 1978.

129. Verbeck, G. J., "Mechanisms of Corrosion of Steel in Concrete," *Corrosion of Metals in Concrete*, SP-49, L. Pepper, R. G. Pike, and J. A. Willett, eds., American Concrete Institute, Farmington Hills, Mich., 1975, pp. 21-38.

130. McDonald, D. B.; Pfeifer, D. W.; and Sherman, M. R., "Corrosion Evaluation of Epoxy-Coated, Metallic Clad and Solid Metallic Reinforcing Bars in Concrete," *Report*

No. FHWA RD-98-153, Federal Highway Administration, Washington D.C., Dec. 1998.

131. Tripler, A. B.; White, E. L.; Haynie, F. H.; and Boyd, W. K., "Methods of Reducing Corrosion of Reinforcing Steel," *NCHRP Report No. 23*, Highway Research Board, Washington, D.C., 1966, 22 pp.

132. Baker, E. A.; Money, K. L.; and Sanborn, C. B., "Marine Corrosion Behavior of Bare and Metallic-Coated Reinforcing Rods in Concrete," *Chloride Corrosion of Steel in Concrete*, STP-692, ASTM, West Conshohocken, Pa., 1977, pp. 30-50.

133. Bird, C. E., and Strauss, F. J., "Metallic Coating for Reinforcing Steel," *Materials Protection*, V. 6, No. 7, July 1967, pp. 48-52.

134. Cornet, I.; Ishikawa, T.; and Bresler, B., "The Mechanism of Steel Corrosion in Concrete Structures," *Materials Protection*, V. 7, No. 3, Mar. 1968, pp. 44-47.

135. Cook, A. R., and Radtke, S. F., "Recent Research on Galvanized Steel for Reinforcement of Concrete," *Chloride Corrosion of Steel in Concrete*, STP-629, ASTM, West Conshohocken, Pa., 1977, pp. 51-60.

136. Cornet, I., and Bresler, B., "Corrosion of Steel and Galvanized Steel in Concrete," *Materials Protection*, V. 5, No. 4, Apr. 1966, pp. 69-72.

137. Griffin, D. F., "Effectiveness of Zinc Coating on Reinforcing Steel in Concrete Exposed to a Marine Environment," *Technical Note No. N-1032*, Naval Civil Engineering Laboratory, Port Hueneme, 1969, 42 pp.

138. Hill, G. A.; Spellman, D. L.; and Stratfull, R. F., "Laboratory Corrosion Tests of Galvanized Steel in Concrete," *Transportation Research Record No. 604*, Transportation Research Board, 1976, pp. 25-30.

139. Pourbaix, M., *Atlas of Electrochemical Equilibria in Aqueous Solutions*, translated from French by J. A. Franklin, Pergamon Press, New York, 1966, pp. 409-410.

140. Unz, M., "Performance of Galvanized Reinforcement in Calcium Hydroxide Solution," *ACI JOURNAL, Proceedings V. 75*, No. 3, Mar. 1978, pp. 91-99.

141. Sople, B., "Corrosion of Reinforcement in Concrete—Part Series D," *Report No. FCB 73-4*, Norwegian Institute of Technology, University of Trondheim, 1973.

142. Arnold, C. J., "Galvanized Steel Reinforced Concrete Bridge Decks: Progress Report," *Report No. FHWA-MI-78-R1033*, Federal Highway Administration, Washington, D.C., 1976.

143. Clear, K. C., "Time-to-Corrosion of Reinforcing Steel in Concrete Slabs, V. 4: Galvanized Reinforcing Steel," *Report No. FHWA-RD-82-028*, Federal Highway Administration, Washington, D.C., 1981.

144. Castleberry, J. R., "Corrosion Prevention for Concrete and Metal Reinforcing in the Construction Industry," *Materials Protection*, V. 7, No. 3, Mar. 1968, pp. 21-28.

145. Clifton, J. R.; Beeghley, H. F.; and Mathey, R. G., "Nonmetallic Coatings for Concrete Reinforcing Bars," *Report No. FHWA-RD-74-18*, Federal Highway Administration, Washington, D.C., 1974, 87 pp.

146. Backstrom, T. E., "Use of Coatings on Steel Embedded in Concrete," *Corrosion of Metals in Concrete*, SP-49,

- L. Pepper, R. G. Pike, and J. A. Willett, eds., American Concrete Institute, Farmington Hills, Mich., 1975, pp. 103-113.
147. Pike, R. G.; Hay, R. E.; Clifton, J. R.; Beeghly, H. F.; and Mathey, R.G., "Nonmetallic Protective Coatings for Concrete Reinforcing Steel," *Transportation Research Record* No. 500, Transportation Research Board, 1974, pp. 36-44.
148. Clear, K. C., *FCP Annual Progress Report—Year Ending Sept. 30, 1978, Project 4B*, Federal Highway Administration, Washington, D.C., 1978.
149. Virmani, Y. P.; Clear, K. C.; and Pasko, T. J., Jr., "Time-to-Corrosion of Reinforcing Steel in Concrete Slabs, V. 5: Calcium Nitrite Admixture or Epoxy-Coated Reinforcing Bars as Corrosion Protection Systems," *Report No. FHWA-RD-83-012*, Federal Highway Administration, Washington, D.C., 1983, 71 pp.
150. Mathey, R. G., and Clifton, J. R., "Bond of Coated Reinforcing Bars in Concrete," *Proceedings*, ASCE, V. 102, ST1, Jan. 1976, pp. 215-229.
151. Clifton, J. R.; Mathey, R. G.; and Anderson, E. D., "Creep of Coated Reinforcing Bars in Concrete," *Proceedings*, ASCE, V. 105, ST10, Oct. 1979, pp. 1935-1947.
152. Johnston, D. W., and Zia, P., "Bond Characteristics of Epoxy Coated Reinforcing Bars," *Report No. FHWA-NC-82-002*, Federal Highway Administration, Washington, D.C., 1982.
153. Clear, K. C., and Hay, R. E., "Time-to-Corrosion of Reinforcing Steel in Concrete Slabs, V. 1: Effect of Mix Design and Construction Parameters," *Report No. FHWA-RD-73-32*, Federal Highway Administration, Washington, D.C., 1973, 103 pp.
154. Craig, R. J., and Wood, L. E., "Effectiveness of Corrosion Inhibitors and Their Influence on the Physical Properties of Portland Cement Mortars," *Highway Research Record* No. 328, Highway Research Board, 1970, pp. 77-88.
155. Griffin, D. F., "Corrosion Inhibitors for Reinforced Concrete," *Corrosion of Metals in Concrete*, SP-49, L. Pepper, R. G. Pike, and J. A. Willett, eds., American Concrete Institute, Farmington Hills, Mich., 1975, pp. 95-102.
156. Rosenberg, A. M.; Gaidis, J. M.; Kossivas, T. G.; and Previte, R. W., "A Corrosion Inhibitor Formulated with Calcium Nitrite for Use in Reinforced Concrete," *Chloride Corrosion of Steel in Concrete*, STP-629, ASTM, West Conshohocken, Pa., 1977, pp. 89-99.
157. Nmai, C. K.; Farrington, S. A.; and Bobrowski, G. S., "Organic-Based Corrosion-Inhibiting Admixture for Reinforced Concrete," *Concrete International*, V. 14, No. 4, Apr. 1992, pp. 45-51.
158. Nmai, C. K., and Krauss, P. D., "Comparative Evaluation of Corrosion-Inhibiting Chemical Admixtures for Reinforced Concrete," *Proceedings of the Third CANMET/ACI International Conference on Durability of Concrete*, SP-145, V. M. Malhotra, ed., American Concrete Institute, Farmington Hills, Mich., May 1994, pp. 245-262.
159. Al-Qadi I. L.; Prowell, B. D.; Weyers, R. E.; Dutta, T.; Gouuru, H.; and Berke, N., "Corrosion Inhibitors and Polymers," *Report No. SHRP-S-666*, Strategic Highway Research Program, National Research Council, Washington, D.C., 1992.
160. Mäder, U., "A New Class of Corrosion Inhibitors for Concrete," *Proceedings of the 2nd Regional Concrete Conference—Concrete Durability in the Arabian Gulf*, Bahrain, Mar. 1995.
161. Berke, N. S.; Hicks, M. C.; and Hoopes, R. J., "Condition Assessment of Field Structures with Calcium Nitrite," *Concrete Bridges in Aggressive Environments*, Philip D. Cady International Symposium, SP-151, R. E. Weyers, ed., American Concrete Institute, Farmington Hills, Mich., 1994, pp. 43-72.
162. Tomosawa, F.; Masuda, Y.; Fukushi, I.; Takakura, M.; and Hori, T., "Experimental Study on the Effectiveness of Corrosion Inhibitors in Reinforced Concrete," *Admixtures for Concrete: Improvement of Properties*, Proceedings of the RILEM International Durability Symposium, Barcelona, 1990, pp. 382-391.
163. Berke, N. S., and Weil, T. G., "Worldwide Review of Corrosion Inhibitors in Concrete," *Advances in Concrete Technology*, CANMET, Ottawa, Canada, 1992, pp. 899-924.
164. Daily, S. F., and Kendall, K., "Corrosion Control of New Reinforced Concrete Structures in Aggressive Environments," *Paper No. NACE Corrosion 98*, National Association of Corrosion Engineers, Houston, Tex., 1998.
165. Scannell, W. T.; Sohahngpurwala, A. A.; Powers, R. G.; and Sagues, A. A., "Selecting Appropriate Long Term Solutions for Reinforced Concrete Bridge Components in Corrosive Environments," *NACE CORROSION/99 Conference*, San Antonio, Tex., Apr. 1999.
166. Purvis, R. L., et al., "Life-Cycle Cost Analysis for Protection and Rehabilitation of Concrete Bridges Relative to Reinforcement Corrosion," *Report No. SHRP S-377*, Strategic Highway Research Program, National Research Council, Washington, D.C., 1994.
167. Sagues, A. A., "Applied Modeling for Corrosion Protection Design for Marine Bridge Substructures," *FDOT Report No. 0510718*, June 1997.
168. Sagues, A. A.; Scannell, W. T.; and Soh, F. W., "Application of a Deterioration Model to Project Future Concrete Reinforcement Corrosion in Dual Marine Bridge," *International Conference on Corrosion and Rehabilitation of Reinforced Concrete Structures*, Orlando, Fla., Dec. 1998.
169. Brockenbrough, R. L., and Boedecker, K. J., Jr., *Highway Engineering Handbook*, McGraw-Hill, New York, N.Y., 1996, p. 10.1.
170. Poston, R. W.; Whitlock, A. R.; and Kesner, K. E., "Condition Assessment Using Nondestructive Evaluation," *Concrete International*, V. 17, No. 1, July 1995, pp. 36-42.
171. Moore, W. M.; Swift, G.; and Milberger, L. J., "An Instrument for Detecting Delamination in Concrete Bridge Decks," *Highway Research Record* 451, HRB, National Research Council, Washington, D.C., 1973, pp. 44-52.
172. Moore, W. M., "Detection of Bridge Deterioration," *Highway Research Record* 451, HRB, National Research Council, Washington, D.C., 1973, pp. 53-61.
173. Henriksen, C., "Impact-Echo Testing," *Concrete International*, V. 17, No. 5, May 1995, pp. 55-58.
174. Sansalone, M., and Carino, N. J., "Detecting Delaminations in Concrete Slabs with and without Overlays Using

the Impact-Echo Method," *ACI Materials Journal*, V. 86, No. 2, Mar.-Apr. 1989, pp. 175-189.

175. Cantor, T. R., and Kneeter, C. P., "Radar and Acoustic Emission Applied to the Study of Bridge Decks, Suspension Cables, and Masonry Tunnel," *Report No. 77-13*, Port Authority of New York and N.J., 1977.

176. Alongi, A. V.; Cantor, T. R.; Kneeter, C. P.; and Alongi, A. Jr., 1982, "Concrete Evaluation by Radar—Theoretical Analysis," *61st Annual Meeting, Transportation Research Board*, Washington, D.C., 1982.

177. Cantor, T. R., and Kneeter, C. P., "Radar as Applied to Evaluation of Bridge Decks," *Transportation Research Record No. 853*, Transportation Research Board, Washington, D. C., 1982.

178. Clemena, C. G., 1980, "Evaluating of Overlaid Bridge Decks with Ground Probing Radar," *Report No. 80-WPI*, Virginia Highway and Transportation Research Council, Charlottesville, Va.

179. Alongi, A. J.; Clemena, C. G.; and Cady, P. D., "Condition Evaluation of Concrete bridges Relative to Reinforcement Corrosion. Volume 3: Method for Evaluating the Condition of Asphalt Decks," *Report No. SHRP-S/FR-92-105*, Strategic Highway Research Program, National Research Council, Washington, D. C., 1992.

180. Davidson, N. and Chase, S. B., "Radar Tomography of Bridge Decks," *Structural Materials Technology III: an NDT Conference, Proceedings of SPIE*, V. 3400, 1998, pp. 250-257.

181. Holt, F. B., and Manning, D. G. "Infrared Thermography for the Detection of Delaminations in Concrete Bridge Decks," *4th Biennial Infrared Information Exchange*, St. Louis, Mo., 1978.

182. Manning, D. G., and Holt, F. B., "Detecting Delamination in Concrete Bridge Decks," *Concrete International*, V. 2, No. 11, Nov.1980, pp. 34.

183. Benz, C. L., and Ulrikson, D. D., "Bridge Evaluation Through Thermal Infrared and Ground Penetrating Radar," *7th Annual International Bridge Conference, Paper No. IBC-90-40*, Pittsburgh, Penn., 1990.

184. Love, B. L., "The Detection of Delamination in Reinforced Bridge Decks Using Infrared Thermography," *Final Report*, Indiana Department of Highways, West Lafayette, Ind., June 1986.

185. Manning, D. G., and Holt, F. B., "Detecting Deterioration in Asphalt Covered Bridge Decks," *Report No. ME-82-03*, Ontario Ministry of Transportation, Downsview, Ontario, Canada, 1982.

186. Winters, P. C., and Frascoia R. I., "Field Comparison of Infrared Thermography and Manual Survey Techniques," *Report No. 88-3*, Vermont Agency of Transportation, Sept. 1988.

187. Erlin, B., and Hime, W., "Chloride Induced Corrosion," *Concrete International*, V. 7, No. 9, Sept. 1985, pp. 23-25.

188. Broomfield, J., *Corrosion of Steel in Concrete*, E&FN Spon, London, UK, 1997.

189. Gaynor, R., "Understanding Chloride Percentages," *Concrete International*, V. 7, No. 9, Sept. 1985, pp. 26-27.

190. Scannell, W. T.; Sohanguhpurwala, A. A.; and Islam, M., "Participant's Workbook: Assessment of Physical Condition of Concrete Bridge Components," *Report No.*

FHWA-SA-97-002, Federal Highway Administration, Washington, D.C., 1994, pp. 3-12.

191. Jackson, D. R.; Soh, F. W.; Scannell, W. T.; Sohanguhpurwala, A. A.; and Islam, M., "Comparison of Chloride Content Analysis Results Using the AASHTO T260 Test Method and Two Field Test Kits," *Paper No. 520, CORROSION/95*, NACE International, Houston, Tex., 1995.

192. Herald, S. E.; Henry, M.; Al-Qadi, I. L.; Weyers, R. E.; Feeney, M. A.; Howlum, S. F.; and Cady, P. D., "Condition Evaluation of Concrete Bridges Relative to Reinforcement Corrosion. Volume 6: Method for Field Determination of Total Chloride Content," *Report No. SHRP S-328*, Strategic Highway Research Program, National Research Council, Washington, D.C., 1993, 155 pp.

193. Jackson, D. R., and Islam, M., "Determination of Chloride Ion Content in Concrete Structures Using Field Analysis Kits: Some Pitfalls," *Proceedings International Conference: Repair of Concrete Structures*, Norwegian Road Research Laboratory, Oslo, Norway, 1997, 263 pp.

194. Alonso, C.; Andrade, C; and Gonzalez, J. A.; "Relation between Resistivity and Corrosion Rate of Reinforcements in Carbonated Mortar Made with Several Cement Types," *Cement and Concrete Research*, V. 8, No. 5, Sept. 1988, pp. 687-698.

195. Flis, J.; Sabol, S.; Pickering, H. W.; Sehgal, A.; Osseo-Asare, K.; and Cady, P. D., "Electrochemical Measurements on Concrete Bridges for Evaluation of Reinforcement Corrosion Rates," *Corrosion*, V. 49, No. 7, July 1993, pp. 601-613.

196. Fraczek, J., "A Review of Electrochemical Principles as Applied to Corrosion of Steel in a Concrete Environment," *Corrosion of Concrete in Chlorides*, SP-102, F. W. Gibson, ed., Farmington Hills, Mich., 1987, pp. 13-24.

197. Hope, B. B.; Page, J. A.; and Ip, A. K. C., "Corrosion Rates of Steel in Concrete," *Cement and Concrete Research*, V. 16, No. 5, Sept. 1986, pp. 771-781.

198. Hope, B. B.; Ip, A. K. C.; and Manning, D. G., "Corrosion and Electrical Impedance in Concrete," *Cement and Concrete Research*, V. 15, No. 3, May 1985, pp. 525-534.

199. Arup, H., "Electrochemical Monitoring of the Corrosion State of Steel in Concrete," *Proceedings, First International Conference on Deterioration of Reinforced Concrete in the Arabian Gulf*, Oct. 1985.

200. Bazzoni, B., and Lazzari, L., "Interpretation of Potential Mapping on Bridge Decks for Reinforcement Corrosion Prediction," *Paper No. 282, CORROSION/94*, NACE International, Houston, Tex., 1994.

201. Clear, K. C., and Hay, R. E. "Time-to-Corrosion of Reinforcing Steel Slabs. V. 2: Electrical Potential Data," *Report No. FHWA-RD-73-22*, Federal Highway Administration, Washington, D. C., 1973.

202. Clemena, C. G.; Jackson, D. R.; and Crawford, G. C., "Benefits of Using Half-Cell Potential Measurements in Condition Survey of Concrete Bridge Decks," *Paper No. 920344*, 71st Annual Meeting, Transportation Research Board, Washington, D.C., 1992.

203. Islam, M. "Corrosion Condition Evaluation of Concrete Structures—A Case Study," *Paper No. 521, CORROSION/95*, NACE International, Houston, Tex., 1995.

204. Jackson, D. R., "Bridge Deck Evaluation Techniques," *Report No. FHWA-DP-33*, Federal Highway Administration, Washington, D.C., Mar. 1978.
205. Stratfull, R. F., "Half-Cell Potentials and The Corrosion of Steel in Concrete," *Report No. CA-HY-MR-5116-7-72-42*, Nov. 1972.
206. Sohahngpurwala, A. A.; Scannell, W. T.; and Jackson, D. R., "Comparison of Commercially Available Half-Cell Array Units Used in Conducting Surveys of Reinforced Concrete Bridges," *Structural Materials Technology—An NDT Conference*, Technomic Publications, Lancaster, Pa., 1994, 63 pp.
207. Flis, J.; Sehgal, A.; Li, D.; Kho, Y-T.; Sabol, S.; Pickering, H.; Osseo-Asare, K.; and Cady, P. D., "Condition Evaluation of Concrete Bridges Relative to Reinforcement Corrosion. Volume 2: Method for Measuring Corrosion Rate of Reinforcing Steel," *Report No. SHRP-S/FR-92-104*, Strategic Highway Research Program, National Research Council, Washington, D.C., 1992, 105 pp.
208. Clear, K. C., "Measuring Rate of Corrosion of Steel in Field Concrete Structures," *Transportation Research Record No. 1211*, Transportation Research Board, Washington, D.C., 1989.
209. Escalante, E.; Whitenon, E.; and Qui, F., "Measuring the Rate of Corrosion of Reinforcing Steel in Concrete—Final Report," *Report No. NBSIR-86-3456*, National Bureau of Standards, Washington, D.C., 1986.
210. Stern, M., and Geary, A. L., "A Theoretical Analysis of the Shape of Polarization Curves," *Journal of the Electrochemical Society*, V. 104, 1957, 56 pp.
211. Stern, M., "A Method for Determining Corrosion Rates from Linear Polarization," *Corrosion*, 14, 440, 1958, p. 440.
212. Jones, D. A., *Principles and Prevention of Corrosion*, Prentice-Hall, Upper Saddle River, N.J., 1996, p. 109.
213. Feliu, S., and Gonzalez, J. A., "Possibilities of the Guard Ring for Electrical Signal Confinement in the Polarization Measurements of Reinforcements," *Corrosion*, V. 46, Dec. 1990, pp. 1015-1020.
214. Scannell, W. T.; Sohahngpurwala, A. A.; and Jackson, D. R., "Comparison of Commercially Available Corrosion Rate Measuring Devices Used in Conducting Surveys of Reinforced Concrete Bridges," *Structural Materials Technology—An NDT Conference*, Technomic Publications, Lancaster, Pa., 1994, 45 pp.
215. Cady, P. D., and Gannon, E. J., "Condition Evaluation of Concrete Bridges Relative to Reinforcement Corrosion. Volume 8: Procedure Manual," *Report No. SHRP-S/FR-92-110*, Strategic Highway Research Program, National Research Council, Washington, D.C., 1992.
216. Elliot, J. F., "Monitoring Prestressed Structures," *ASCE Civil Engineering*, V. 66, No. 7, July 1996, pp. 61-63.
217. Ghorbanpoor, A., "Evaluation of Post-tensioned Concrete Bridge Structures by the Impact-Echo Technique," *Report No. FHWA-RD-92-096*, Federal Highway Administration, Washington, D.C., 1993.
218. Jaeger, B. J.; Sansalone, M. J.; and Poston, R. W., "Detecting Voids in Grouted Tendon Ducts of Post-Tensioned Concrete Structures," *ACI Structural Journal*, V. 93, No. 4, July-Aug. 1996, pp. 462-473.
219. Jaeger, B. J.; Sansalone, M. J.; and Poston, R. W., "Using Impact-Echo to Assess Tendon Ducts," *Concrete International*, V. 19, No. 2, Feb. 1997, pp. 42-46.
220. Andrade, C., and Sanjuan, M. A., "Experimental Procedure for the Calculation of Chloride Diffusion Coefficients in Concrete from Migration Tests," *Advances in Cement Research*, V. 6, No. 23, 1994, pp. 127-134.
221. Burke, P. A., "Status of Nation's Bridges," *Materials Performance*, V. 33, No. 6, June 1994, p. 48.
222. Weyers, R. E., ed., *Concrete Bridges in Aggressive Environments, Proceedings of Philip D. Cady International Symposium*, SP-151, American Concrete Institute, Farmington Hills, Mich., 1994, 296 pp.
223. Jones, N. P., and Ellingwood, B. R., "NDE of Concrete Bridges: Opportunities and Research Needs," *Proceedings of Conference on Nondestructive Evaluation of Bridges*, FHWA-RD-93-040A DOT-VNTSC-FHWA-93-1, Federal Highway Administration, Turner-Fairbank Highway Research Center, McLean, Va., 1993.
224. Khan, M. S.; Sohahngpurwala, A. A.; and Scannell, W. T., "Corrosion-Induced Deterioration in Conventionally Reinforced and Post-Tensioned Concrete Balconies," *NACE Annual Conference, Paper No. 519*, CORROSION 95, National Association of Corrosion Engineers, Houston, Tex., 1995, pp. 519/1 to 519/12.
225. Bickley, J. A., and Liscio, R., "Monitoring Parking Structure Repairs," *Concrete International*, V. 19, No. 1, Jan. 1997, pp. 34-40.
226. O'Connor, J. P., and Kolf, P. R., "High-Rise Facade Evaluation and Rehabilitation," *Concrete International*, V. 15, No. 9, Sept. 1993, pp. 50-55.
227. Frascoia, R. I., *Waterproofing Membranes—Are Their Problems Insurmountable*, FCP Project 4B Review, State College, Pa., Sept. 1976.
228. Sprinkel, M. M., "Twenty-Year Performance of Latex-Modified Concrete Overlays," *Transportation Research Record 1335*, Transportation Research Board, Washington, D.C., 1992, pp. 27-35.
229. Slater, John E.; Lankard, D. R.; and Moreland, P. J., "Electrochemical Removal of Chlorides from Concrete Bridge Decks," *Materials Protection*, V. 15, No. 11, Nov. 1976, pp. 21-26.
230. Morrison, G. L.; Virmani, Y. P.; Stratton, F. W.; and Gilliland, W. J., "Chloride Removal and Monomer Impregnation of Bridge Deck Concrete by Electro-Osmosis," *Report No. FHWA-KS-RD 74-1*, Kansas Department of Transportation, 1976.
231. Bennett, J. E.; Thomas, T. J.; Clear, K. C.; Lankard, D. L.; Hartt, W. H.; and Swiat, W. J., "Electrochemical Chloride Removal and Protection of Concrete Bridge Components, Volume I: Laboratory Studies," *Report No. SHRP S-657*, Strategic Highway Research Program, National Research Council, Washington, D.C., 1993.
232. Bennett, J. E.; Fong, K. F.; and Shue, T. J., "Electrochemical Chloride Removal and Protection of Concrete Bridge Components, V. 2 Field Trials," *Report No. SHRP S-669*, Strategic Highway Research Program, National Research Council, Washington, D.C., 1993.

233. Bennett, J. E., and Schue, T. J., "Chloride Removal Implementation Guide, Report No. SHRP S-347, Strategic Highway Research Program, National Research Council, Washington, D.C., 1993.

234. Al-Qadi, I. L.; Prowell, B. D.; Weyers, R. E.; Dutta, T.; Gouru, H.; and Berke, N., "Concrete Bridge Protection and Rehabilitation: Chemical and Physical Techniques—Corrosion Inhibitors and Polymers," Report No. SHRP S-666, Strategic Highway Research Program, National Research Council, Washington, D.C. 1993.

235. Gannon, E. J.; Cady, P. D.; and Weyers, R. E., "Price and Cost Information," Report No. SHRP S-664, Strategic Highway Research Program, National Research Council, Washington, D.C., 1992.

236. Cady, P. D. and Weyers, R. E., "Deep Polymer Impregnation of a Bridge Deck Using the Grooving Technique," Report FHWA-PA-85-014, Pennsylvania Transportation Institute, Pennsylvania State University, University Park, Pa., 1986.

237. Gummow, R. A., and Meyers, J. R., *Corrosion Mitigation by Cathodic Protection*, National Association of Corrosion Engineers, Houston, Tex., 1986.

238. Han, M. K.; Snyder, M. J.; Simon, P. D.; Davis, G. O.; and Hindin, B., "Cathodic Protection of Concrete Bridge Components," *Quarterly Report SHRP-87-C-107B*, Apr. 1989.

239. Whiting, D.; Nagi, M.; and Broomfield, J. P., "Evaluation of Sacrificial Anodes for Cathodic Protection of Reinforced Concrete Bridge Decks," Report No. FHWA-RD-95-041, Federal Highway Administration, Turner-Fairbank Highway Research Center, McLean, Va., 1995.

240. *Guide Specification for Cathodic Protection of Concrete Bridge Decks*, AASHTO-AGC-ARTBA Subcommittee on New Highway Materials, Task Force 29, 1992.

241. "Cathodic Protection of Concrete Bridges: A Manual of Practice," Report No. SHRP-S-372, Strategic Research Program, National Research Council, Washington, D.C., 1993.

242. Bennett, J., and Turk, T., "Technical Alert—Criteria for the Cathodic Protection of Reinforced Concrete Bridge Elements," Report No. SHRP-S-359, Strategic Research Program, National Research Council, Washington, D.C., 1994.

6.3—Other references

Bergen, J. V., and Brown, B. C., 1975. "An Evaluation of Concrete Bridge Deck Resurfacing in Iowa," *Special Report*, Iowa State Highway Commission, Ames, Iowa.

Berke, N. S., and Hicks, M. C., 1990. "Electrochemical Methods of Determining Corrosivity of Steel in Concrete," *Corrosion Testing and Evaluation: Silver Anniversary Volume*, ASTM STP 1000, R. Baboian and S. W. Dean, eds., American Society for Testing and Materials, Conshohocken, Pa., pp. 425-440.

Bukovatz, J. E.; Crumpton, C. F.; and Worley, H. E., 1973. "Bridge Deck Deterioration Study, Final Report," State Highway Commission of Kansas, Topeka, Kans.

Fidjestøl, P.; Askheim, N. E.; and Roland, B., "Location of Potential Corrosion Areas in Concrete Marine Structures," *Concrete in the Oceans, Phase II*, Plc, Final Report.

Hilton, N., 1964. "A Two-Inch Bonded Concrete Overlay for the Port Mann Bridge," *Engineering Journal* (Montreal), May, pp. 39-44.

"Impurities in Aggregates for Concrete," 1970. *Advisory Note No. 18*, Cement and Concrete Association, London, 8 pp.

Jenkins, G. H., and Butler, J. M., 1975. "Internally Sealed Concrete," Report No. FHWA-RD-75-20, Federal Highway Administration, Washington, D.C., 106 pp.

Manning, D. G., and Owens, M. J., 1979. "Ontario's Experience with Concrete Overlays for Bridge Decks," *RTAC Forum* (Ottawa), V. 2, No. 1, pp. 31-37.

O'Connor, E. J., 1977. "Iowa Method of Partial-Depth Portland Cement Resurfacing of Bridge Decks," *Chloride Corrosion of Steel in Concrete*, STP-629, ASTM, West Conshohocken, Pa., pp. 116-123.

Tracy, R. G., 1976. "Bridge Deck Deterioration and Restoration Investigation No. 639," *Interim Report*, Minnesota Department of Transportation, St. Paul, Dec.

Tyson, S. S., 1976. "Two-Course Bonded Concrete Bridge Deck Construction—Interim Report No. 2: Concrete Properties and Deck Condition Prior to Opening to Traffic," Report No. VHTRC-R3, Virginia Highway and Transportation Research Council, Charlottesville.