



Taller de Estructuras N°1

Prof. Titular Ordinario Ing. Ernesto R. Villar – Nivel IV

Prof. Titular Ordinario Ing. Jorge E. Faréz – Nivel III

Prof. Adjunto Ing. Miguel Lozada – Nivel II

Prof Adjunta interina Ing. Patricia Langer – Nivel I

Nivel III Titular: Ing. Jorge E. Faréz

Martes: Arq. Estela Ravassi

Ing. Luciano Faréz

Viernes: Ing. Raúl Rimoldi

Arq. Nair Farez



Universidad Nacional de La Plata



Facultad de Arquitectura y Urbanismo

PORTICOS

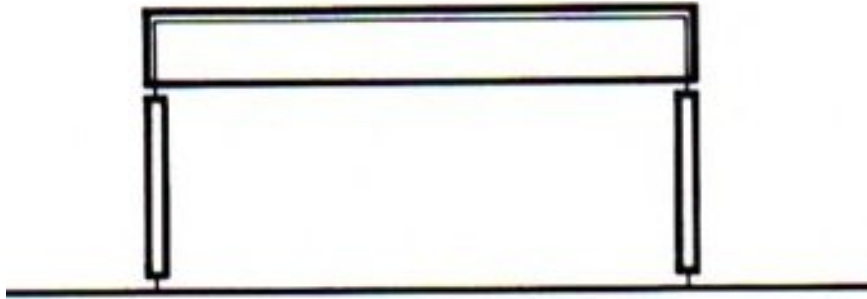

RIGIDEZ DEL PORTICO



DEFORMACION POR FLEXION

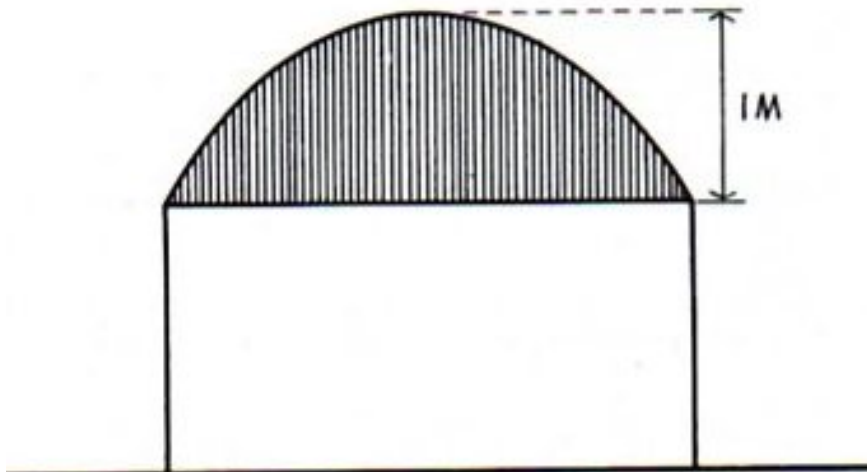

TENSIONES DE FLEXION

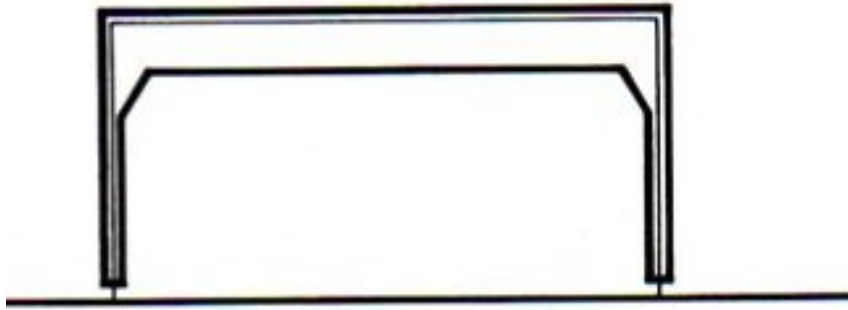

RIGIDEZ DEL PORTICO

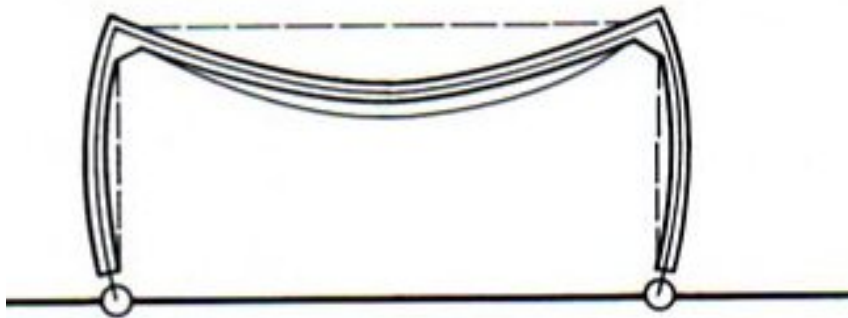

DEFORMACION POR FLEXION

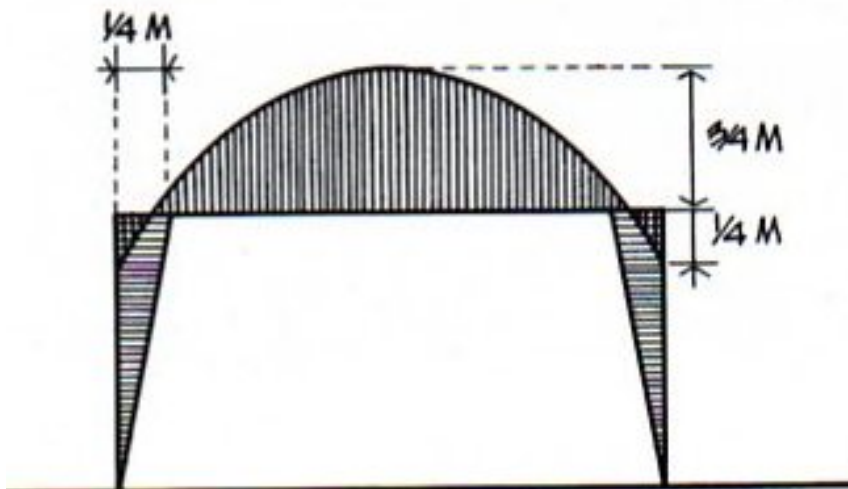

TENSIONES DE FLEXION

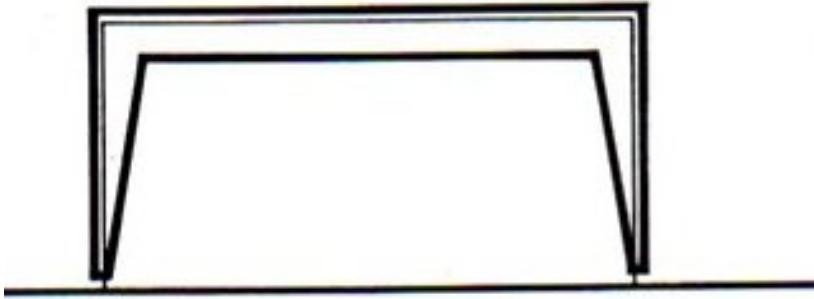

RIGIDEZ DEL PORTICO

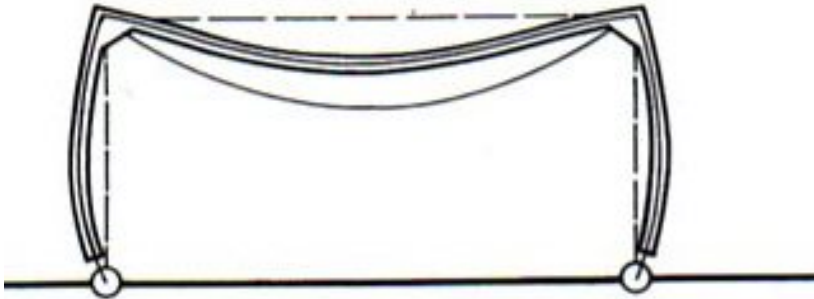

DEFORMACION POR FLEXION

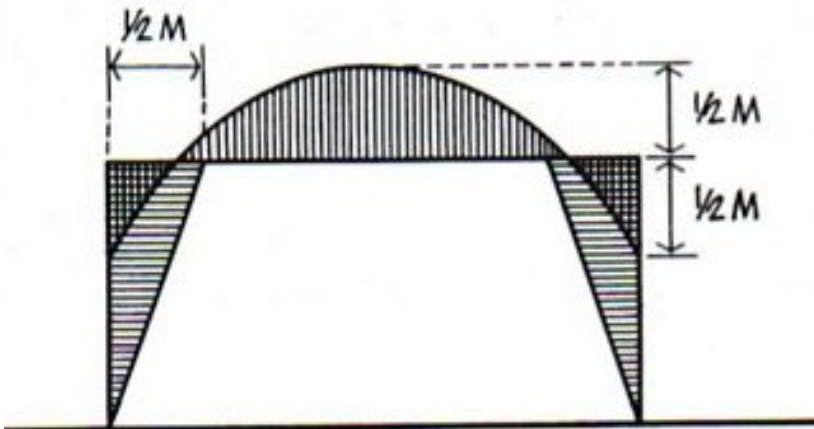

TENSIONES DE FLEXION

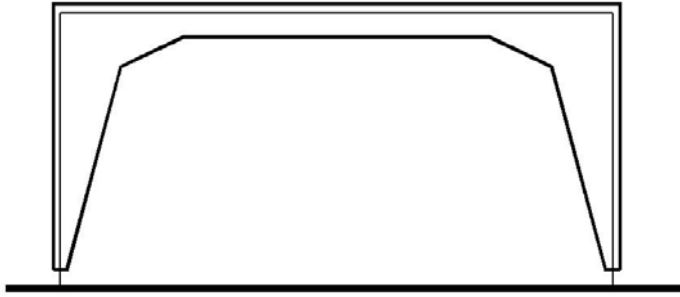

RIGIDEZ DEL PORTICO

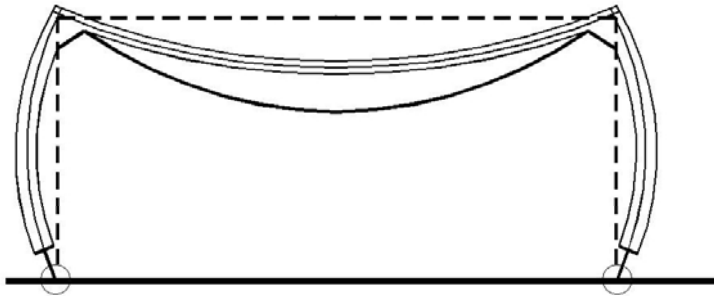

DEFORMACION POR FLEXION

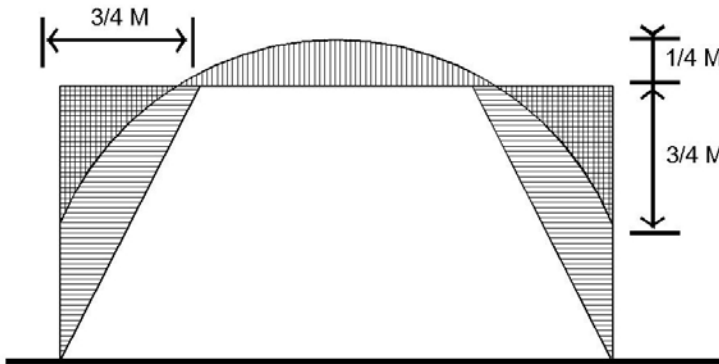

TENSIONES DE FLEXION

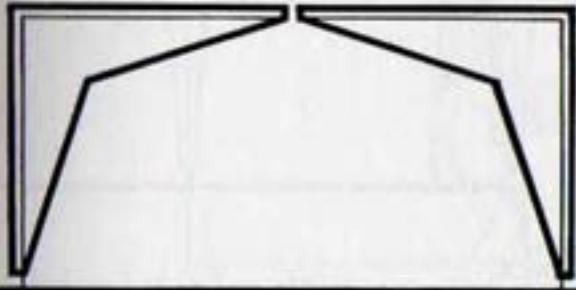

RIGIDEZ DEL PORTICO

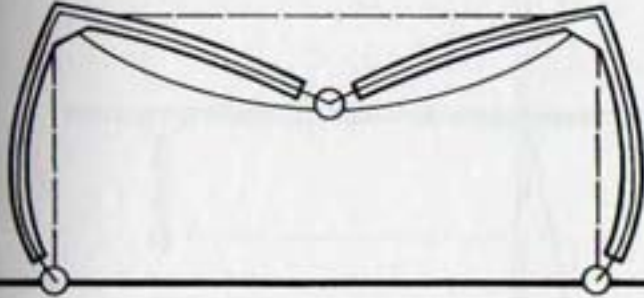

DEFORMACION POR FLEXION

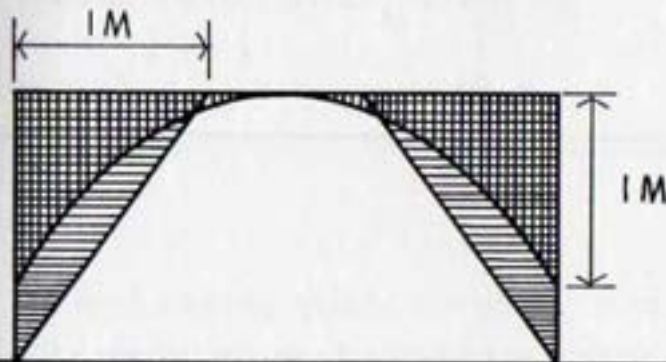

TENSIONES DE FLEXION

Mecanismo de portico y su relacion con la viga de voladizos

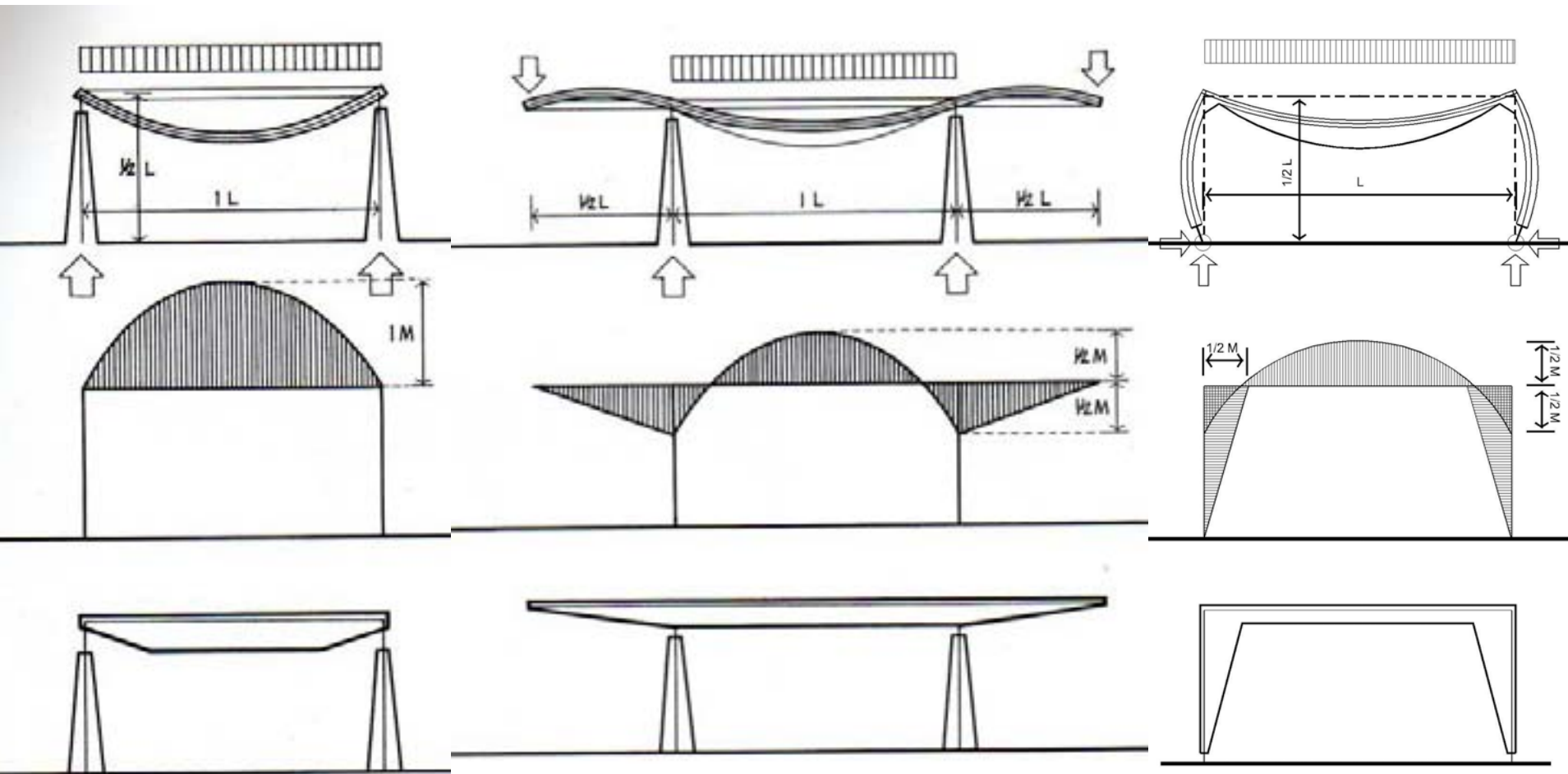

SISTEMA ESTRUCTURAL

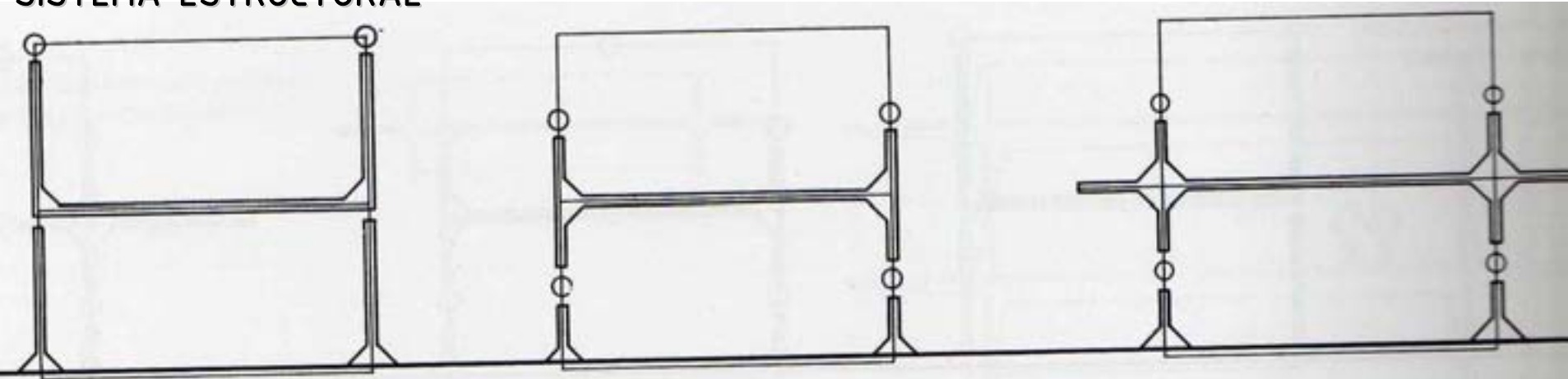

BAJO CARGA VERTICAL

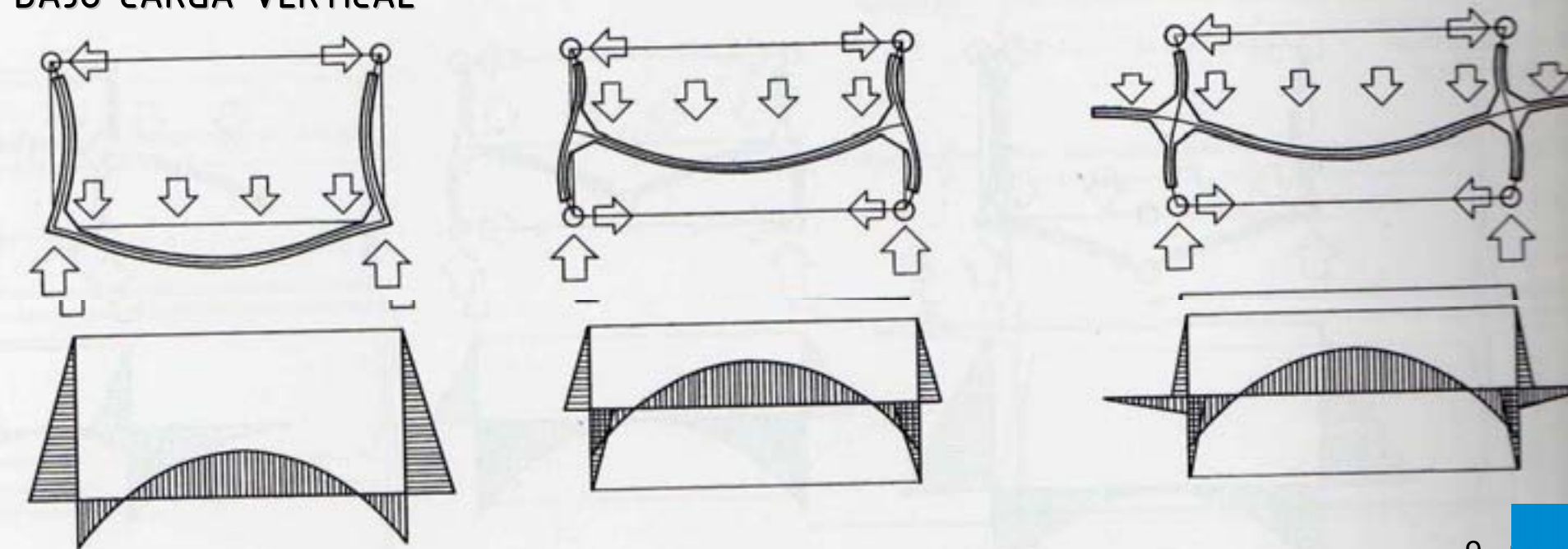

BAJO CARGA HORIZONTAL

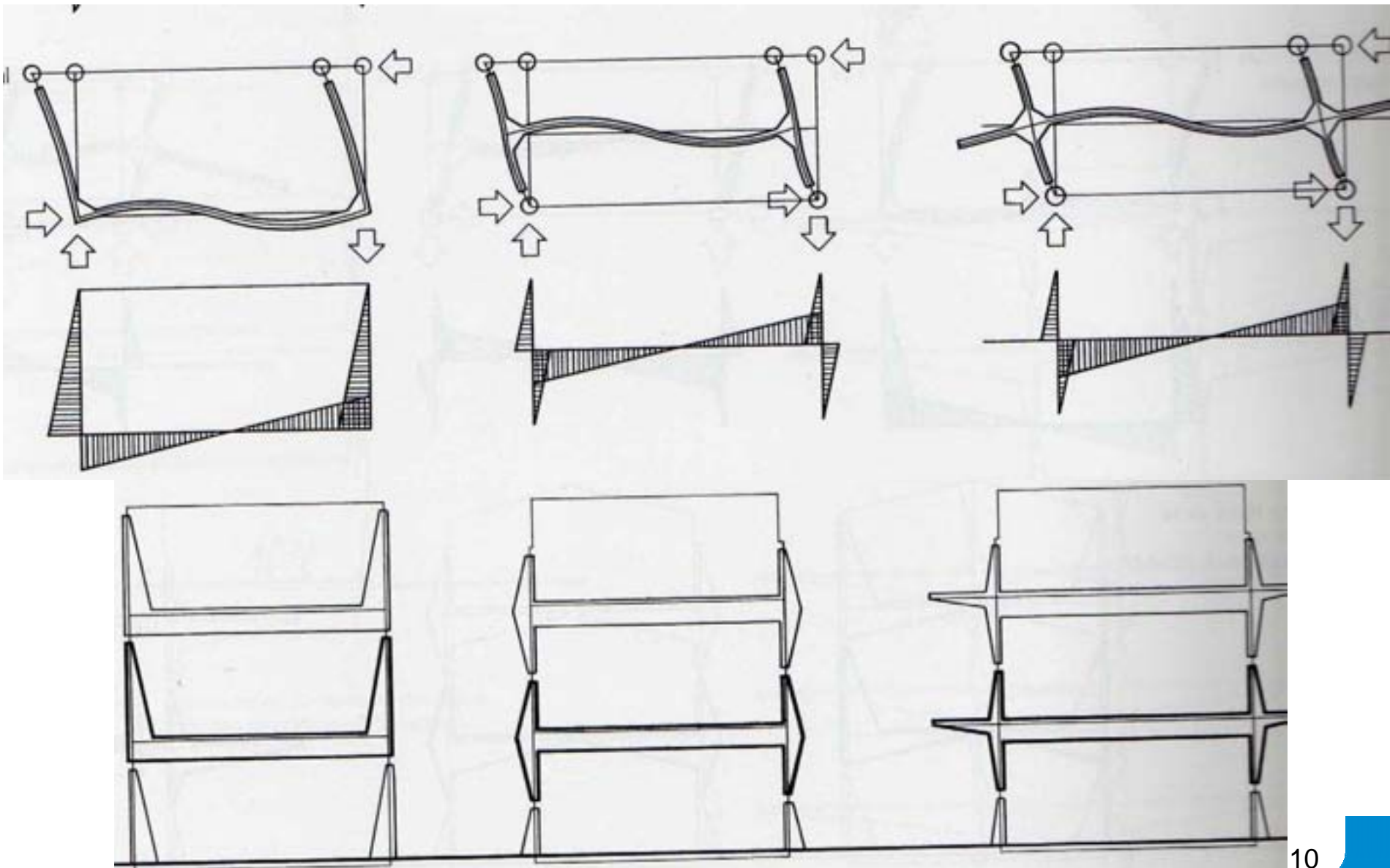

SISTEMA ESTRUCTURAL

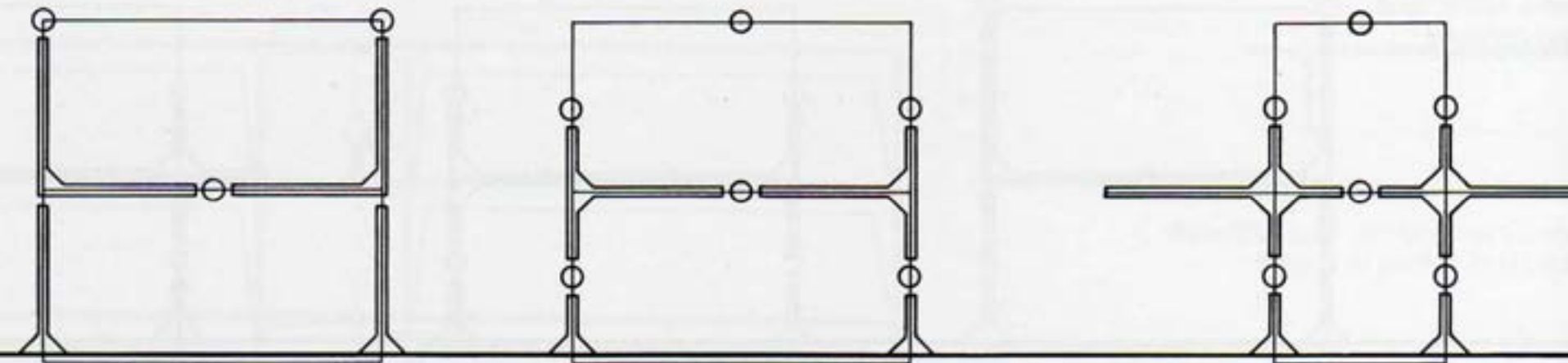

BAJO CARGA VERTICAL

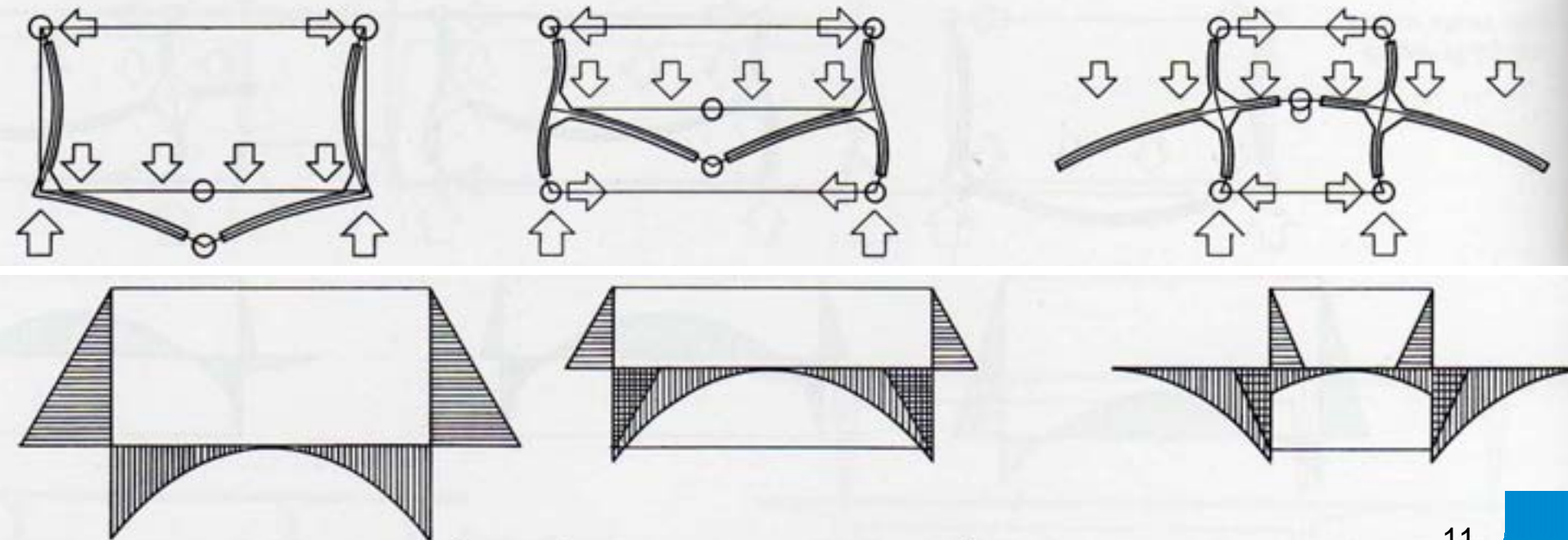

BAJO CARGA HORIZONTAL

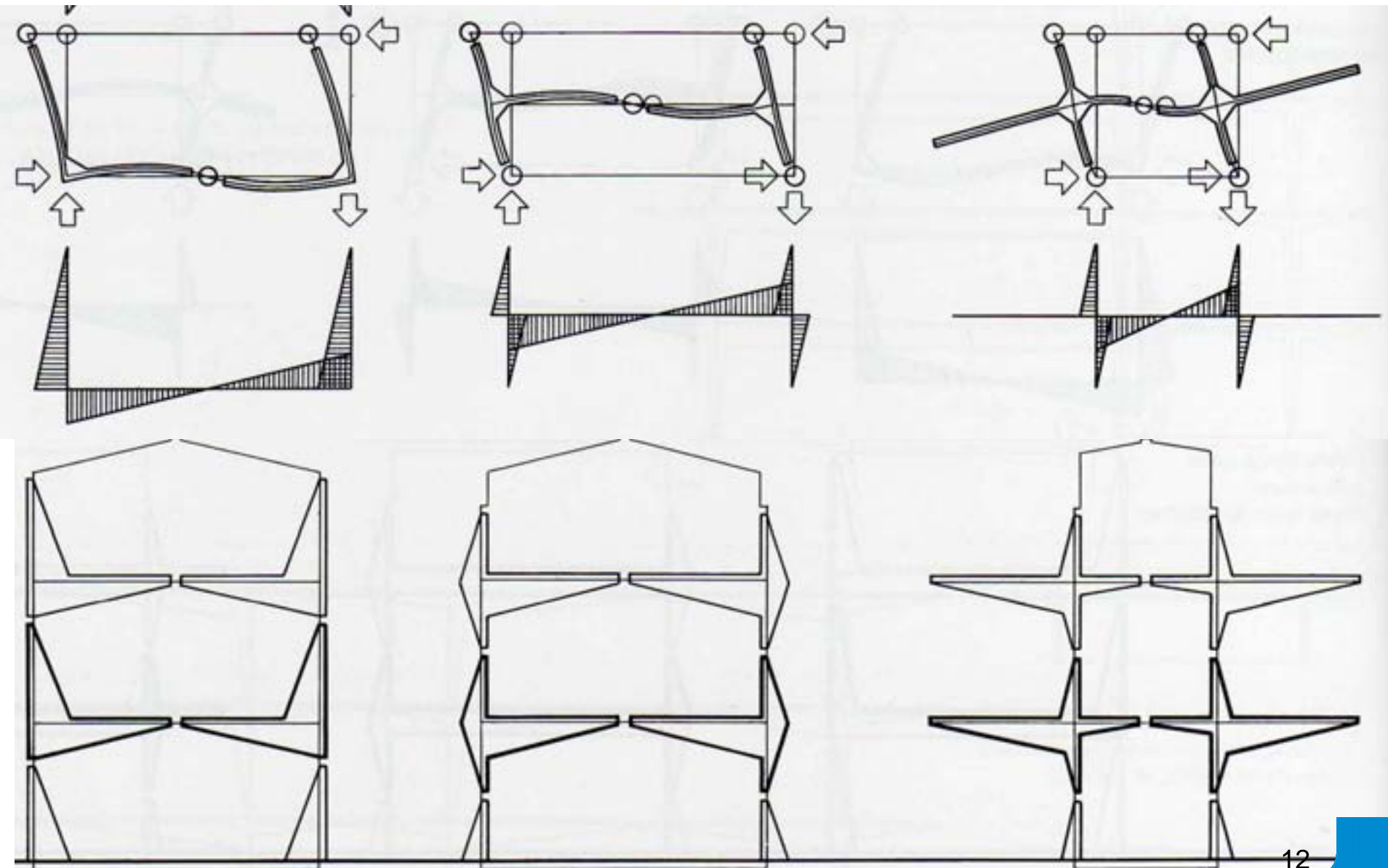

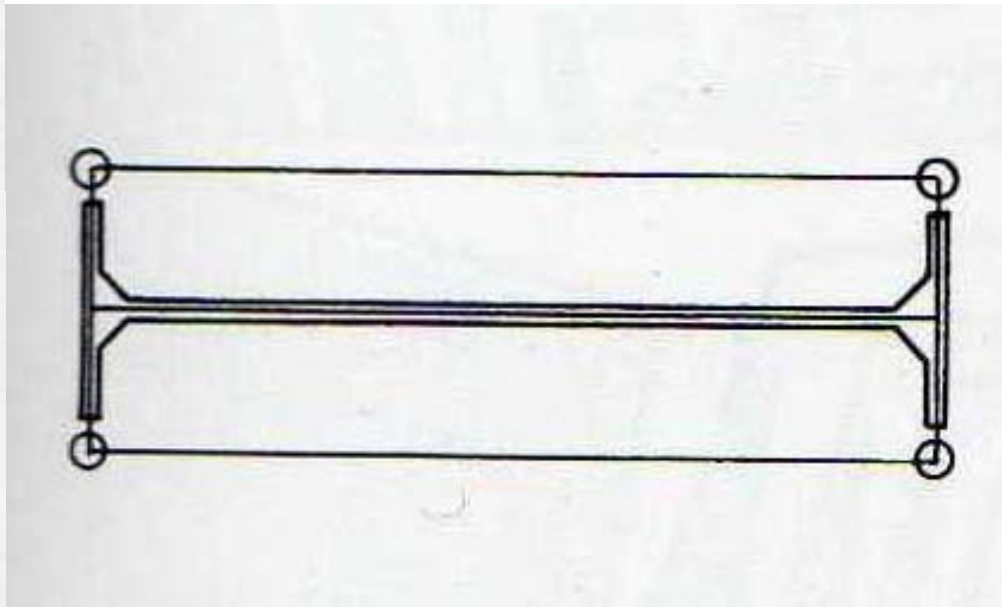

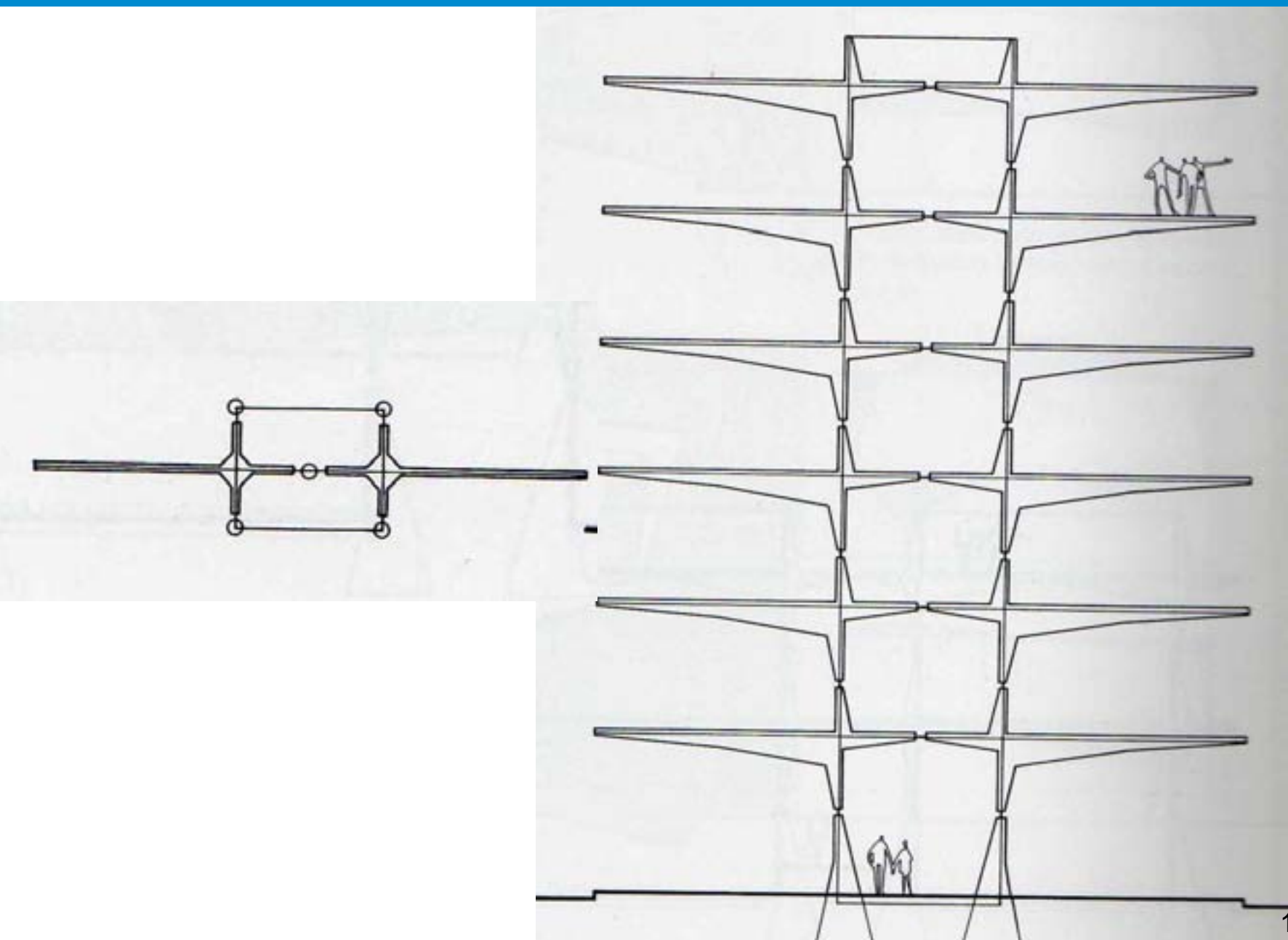

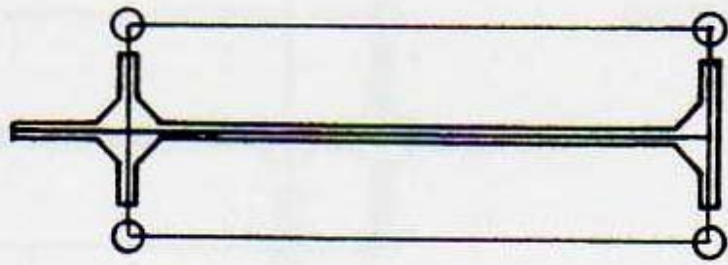
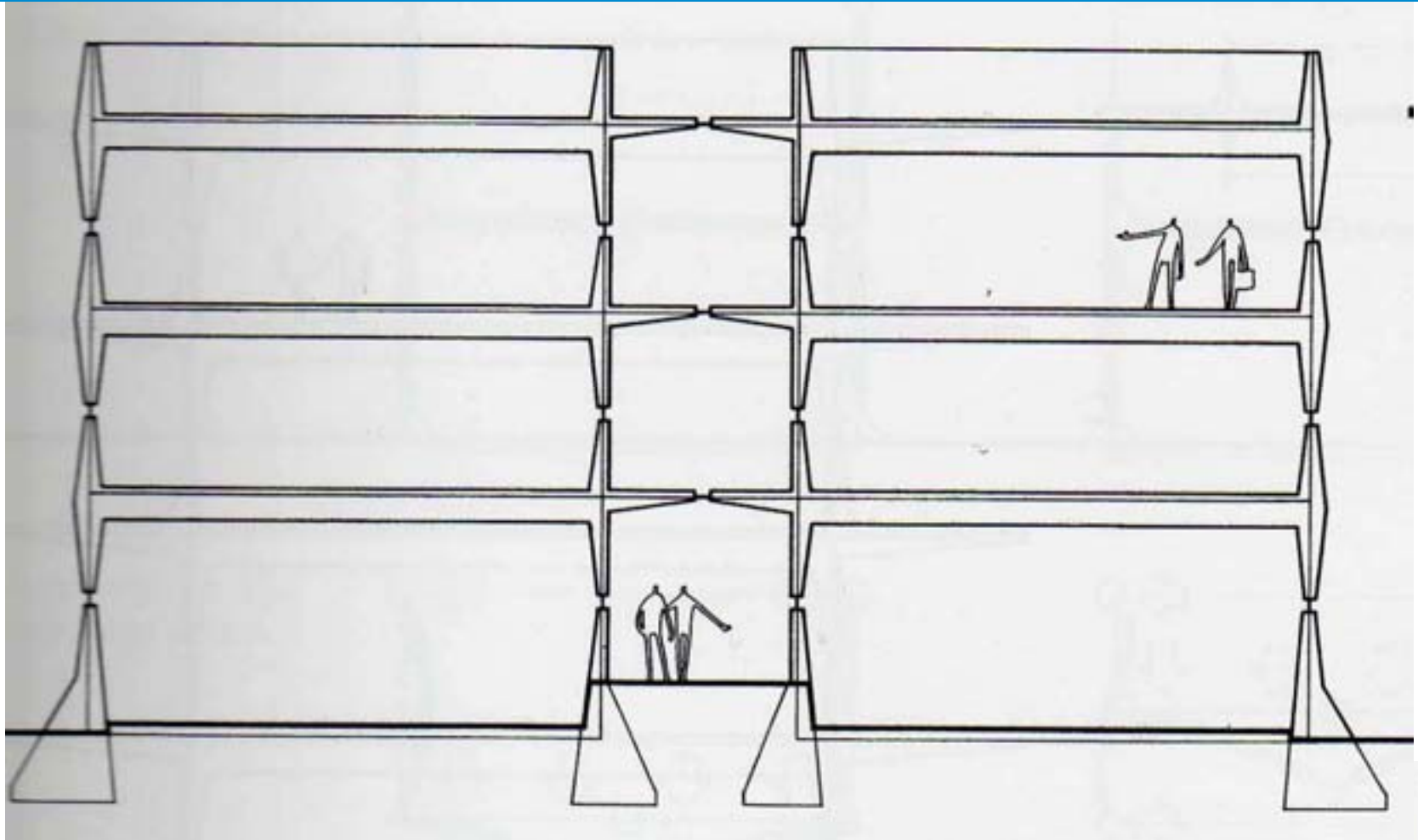

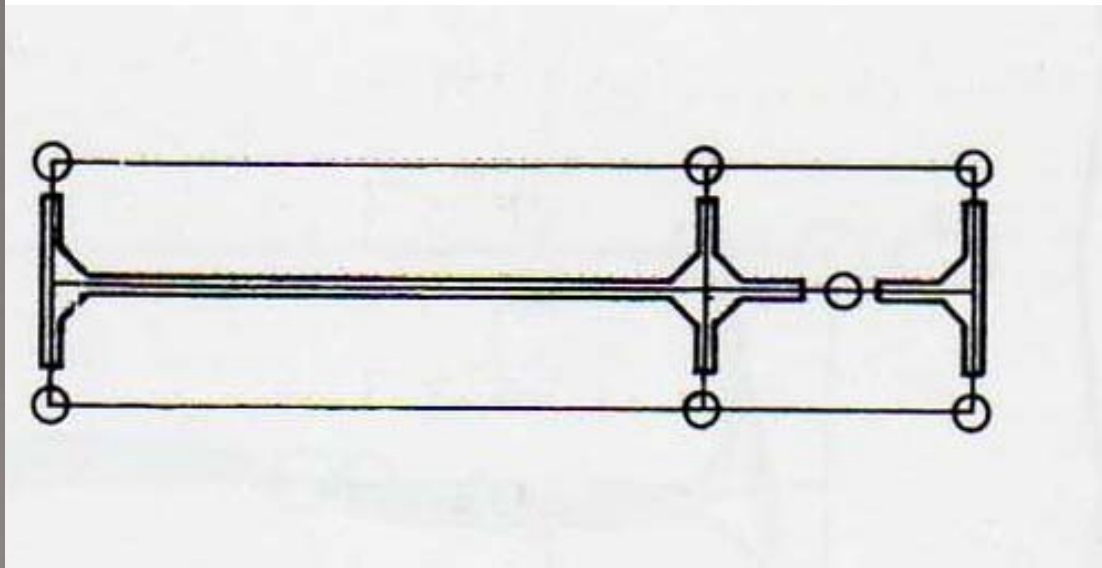
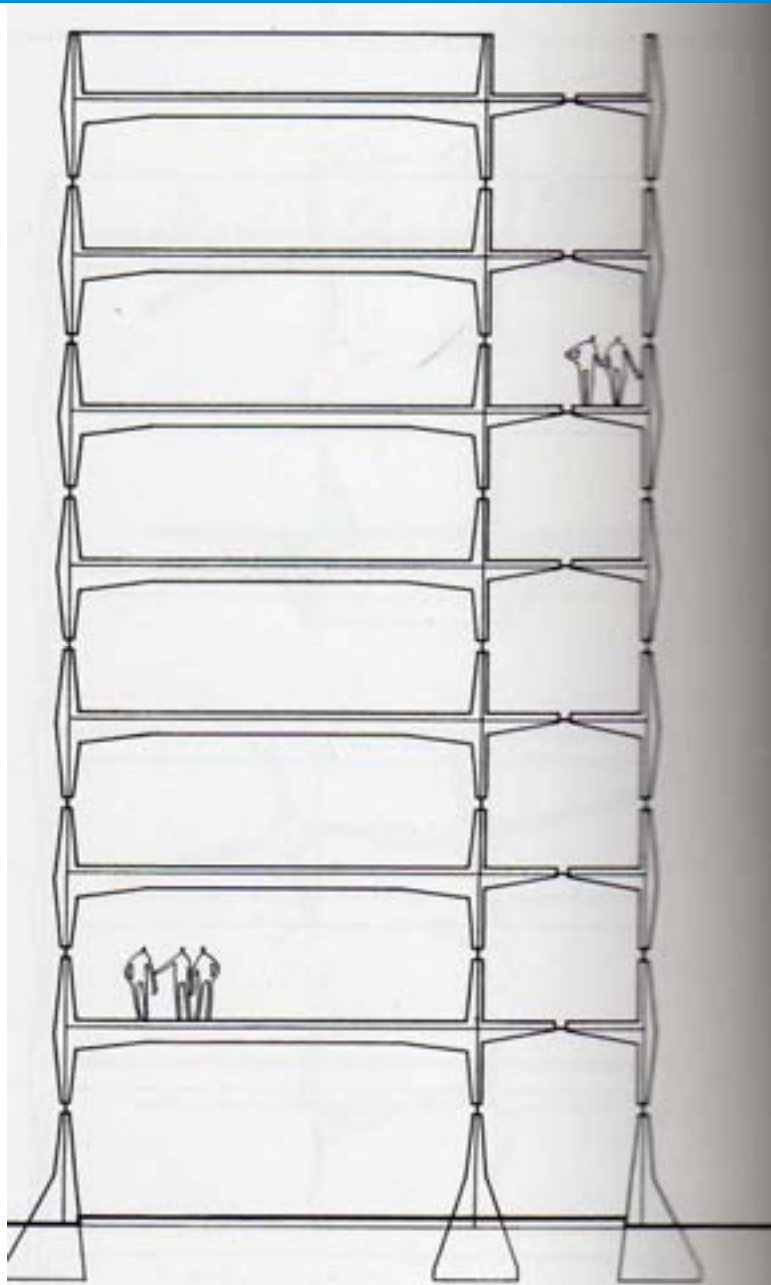

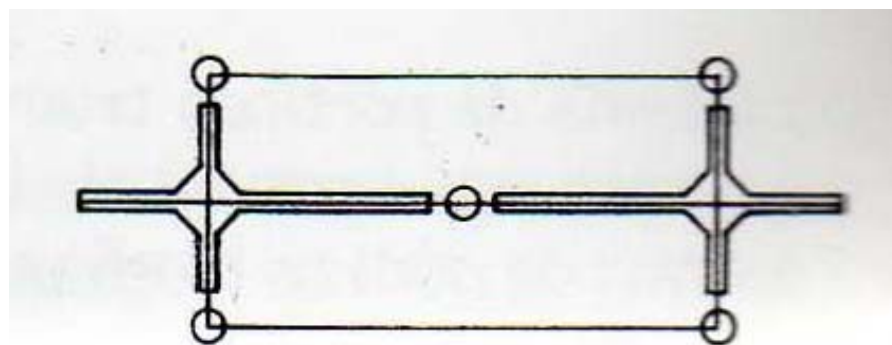
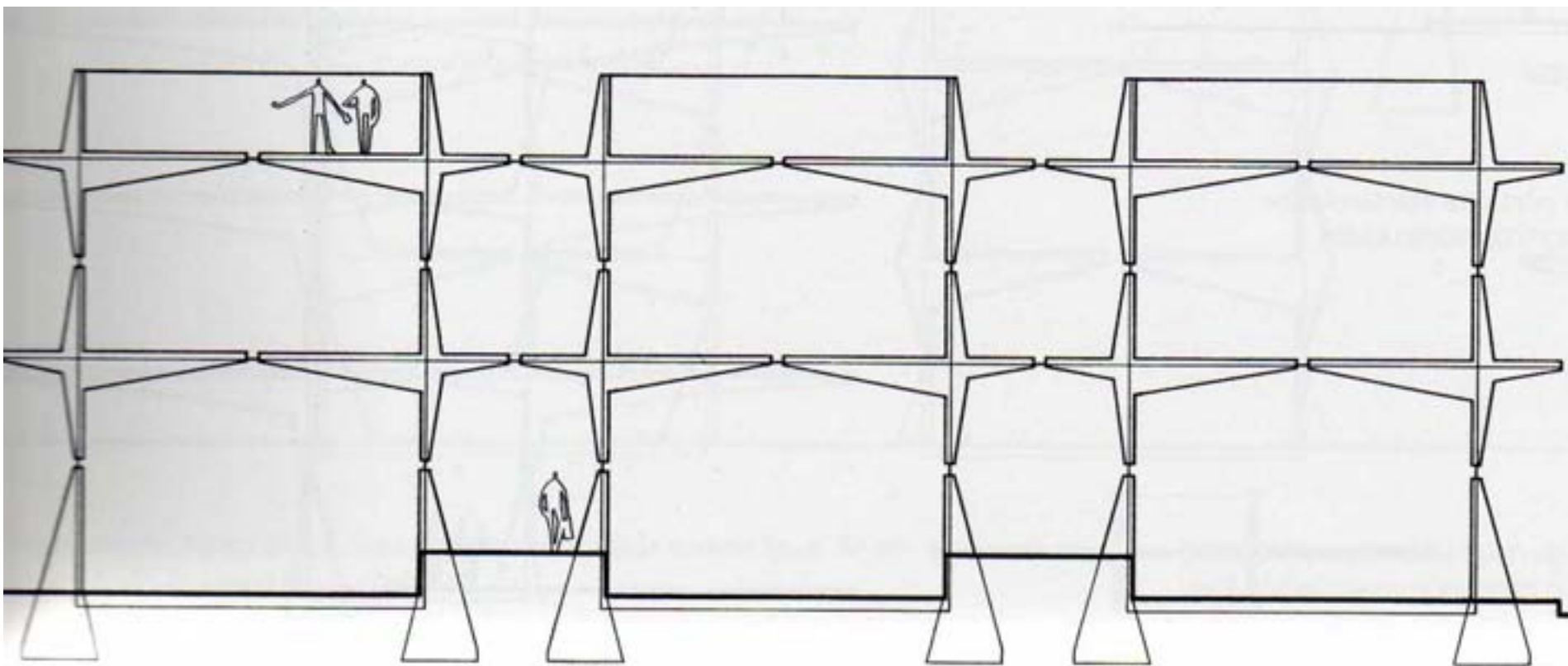

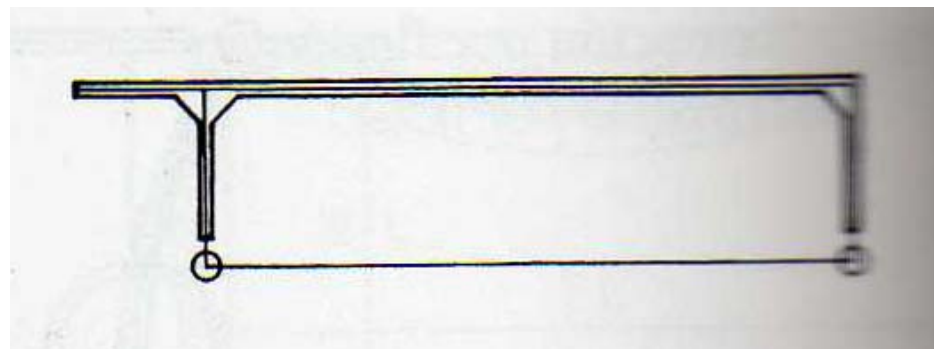
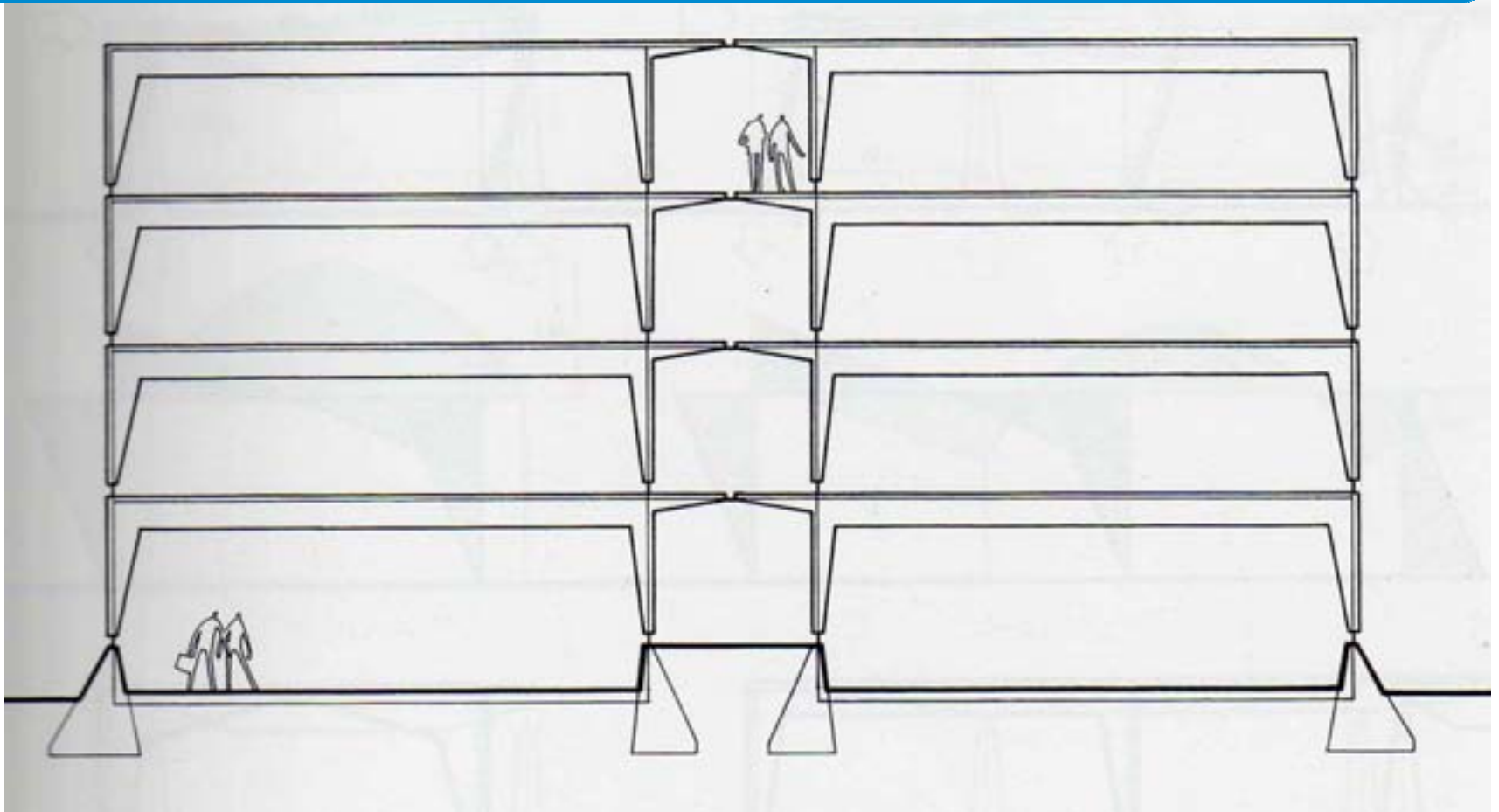

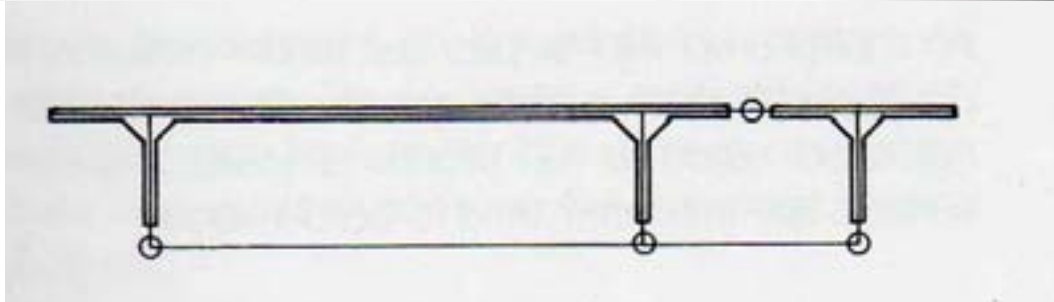
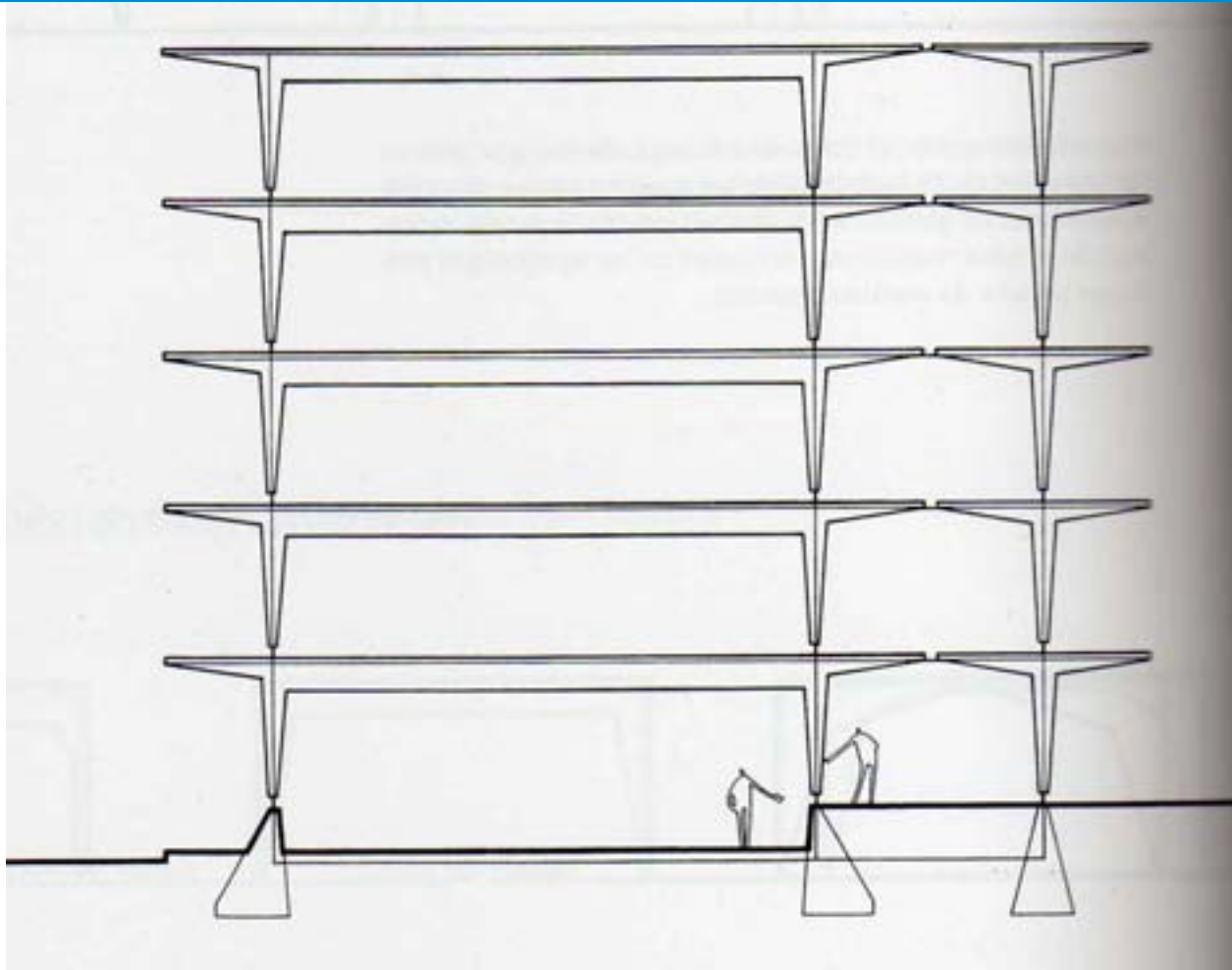

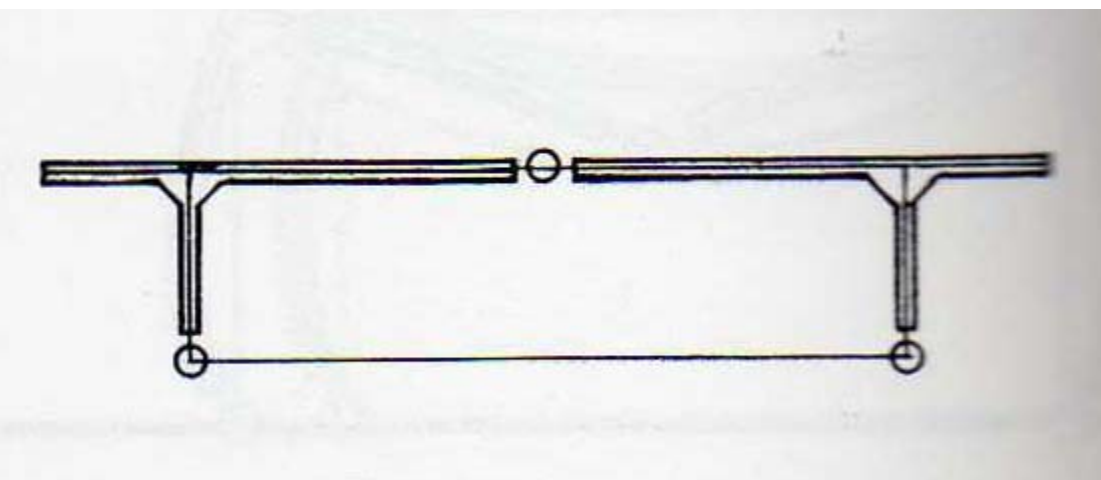
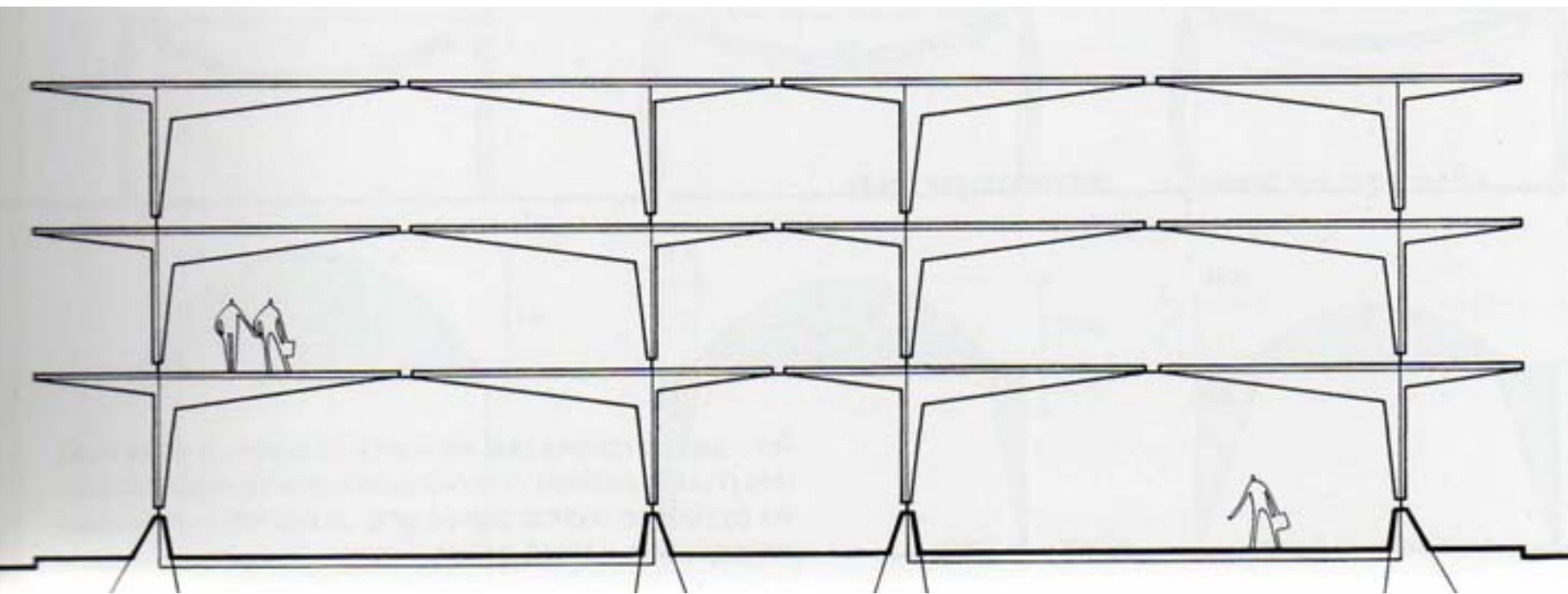

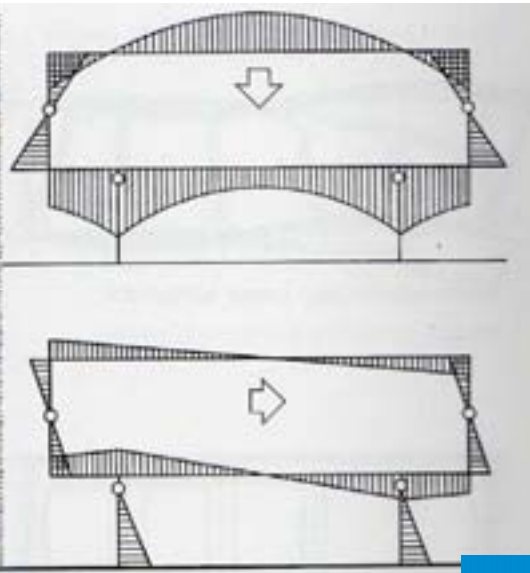
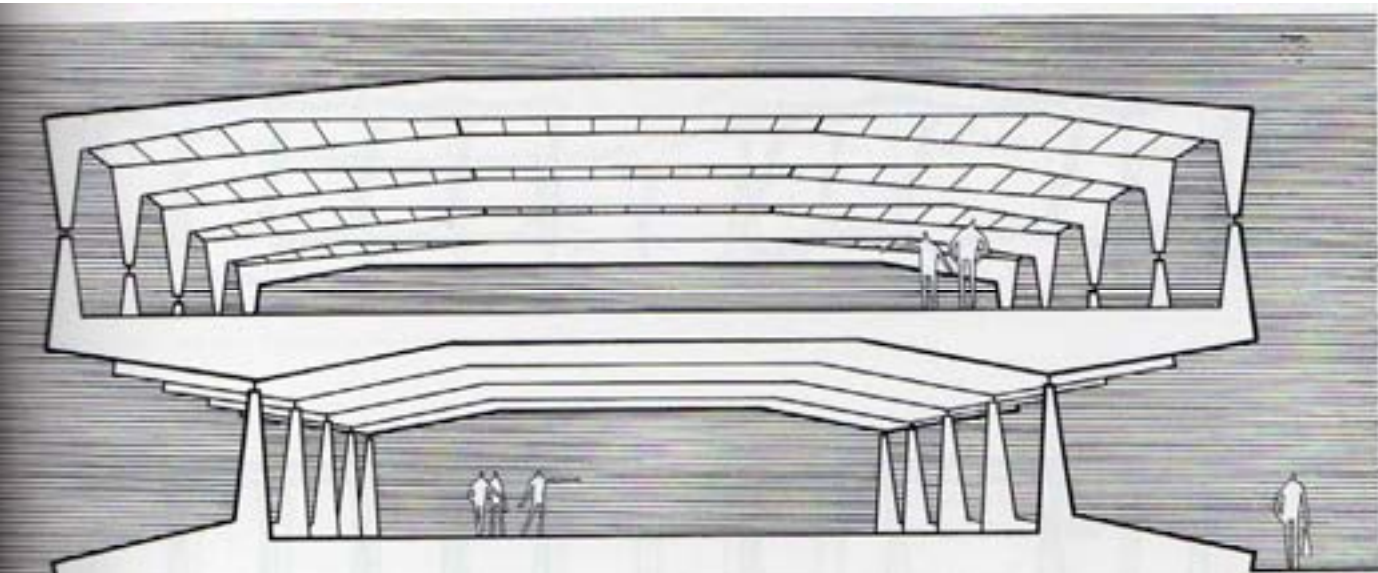
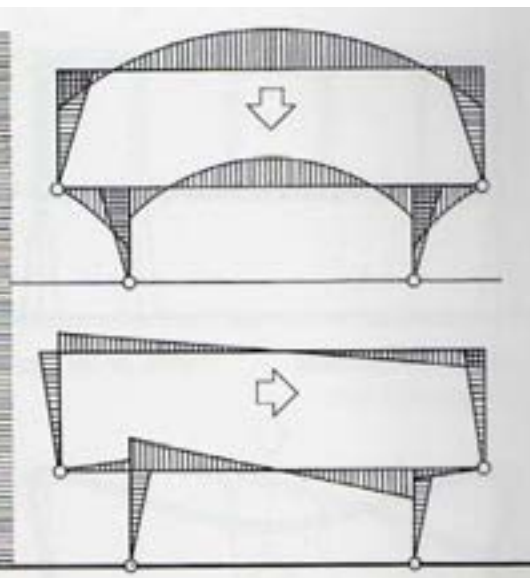
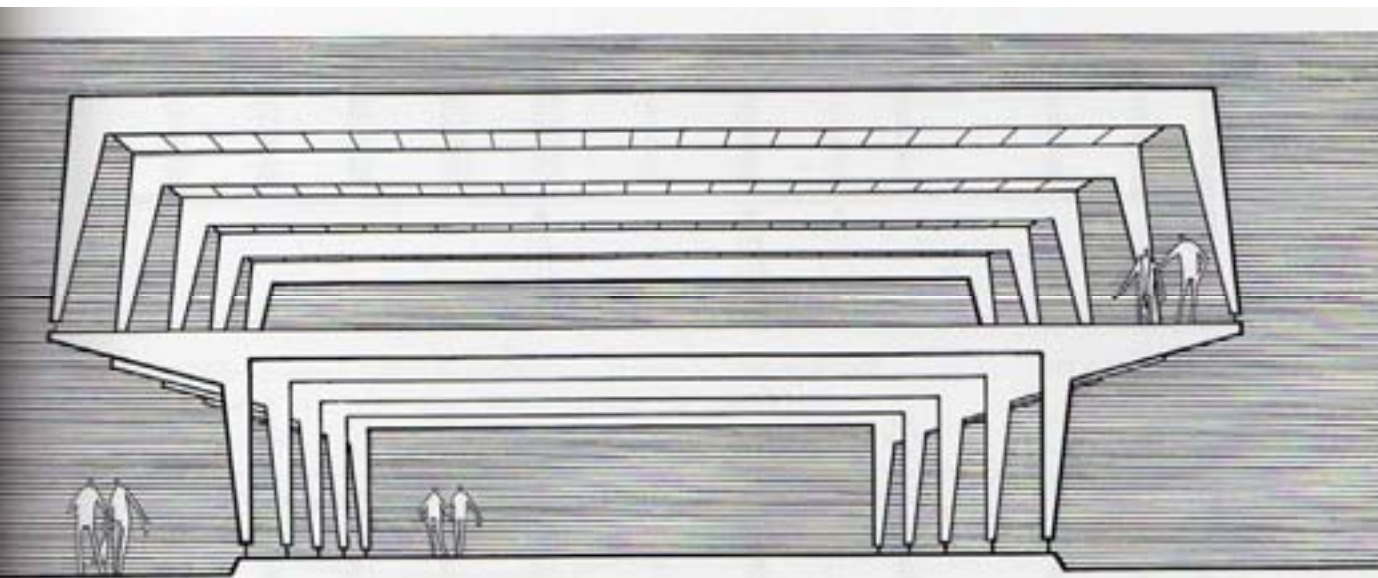

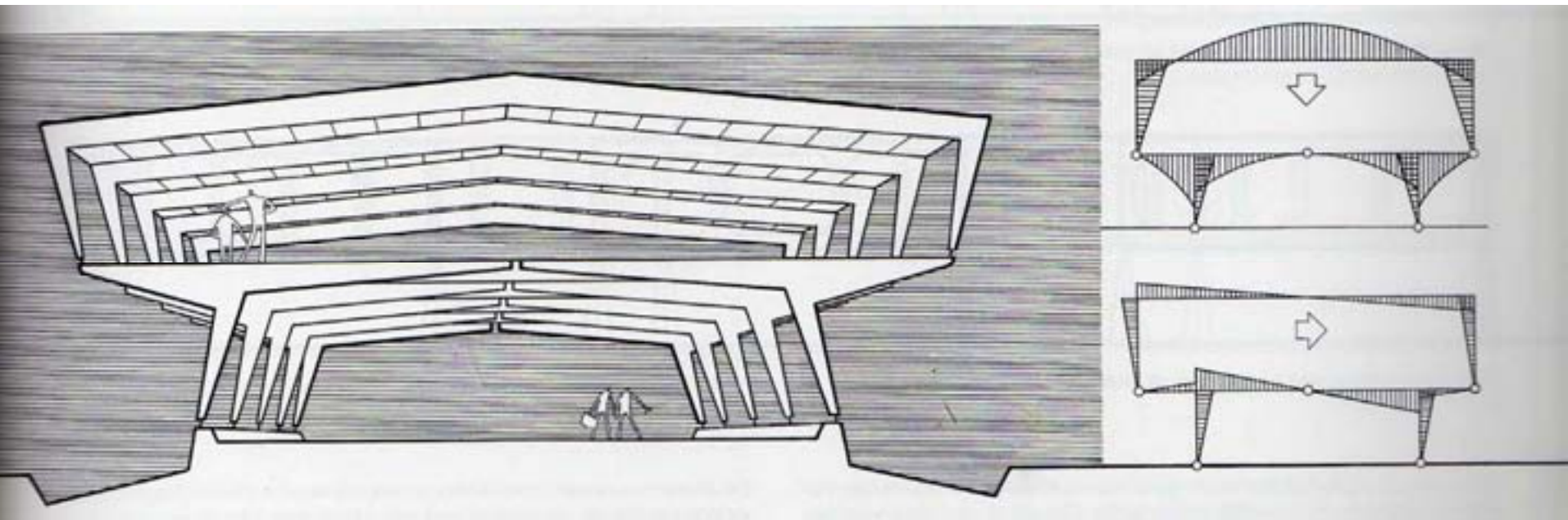

EJEMPLOS

BREUER

SEDE DE LA UNESCO



PLANTA GENERAL DEL CONJUNTO

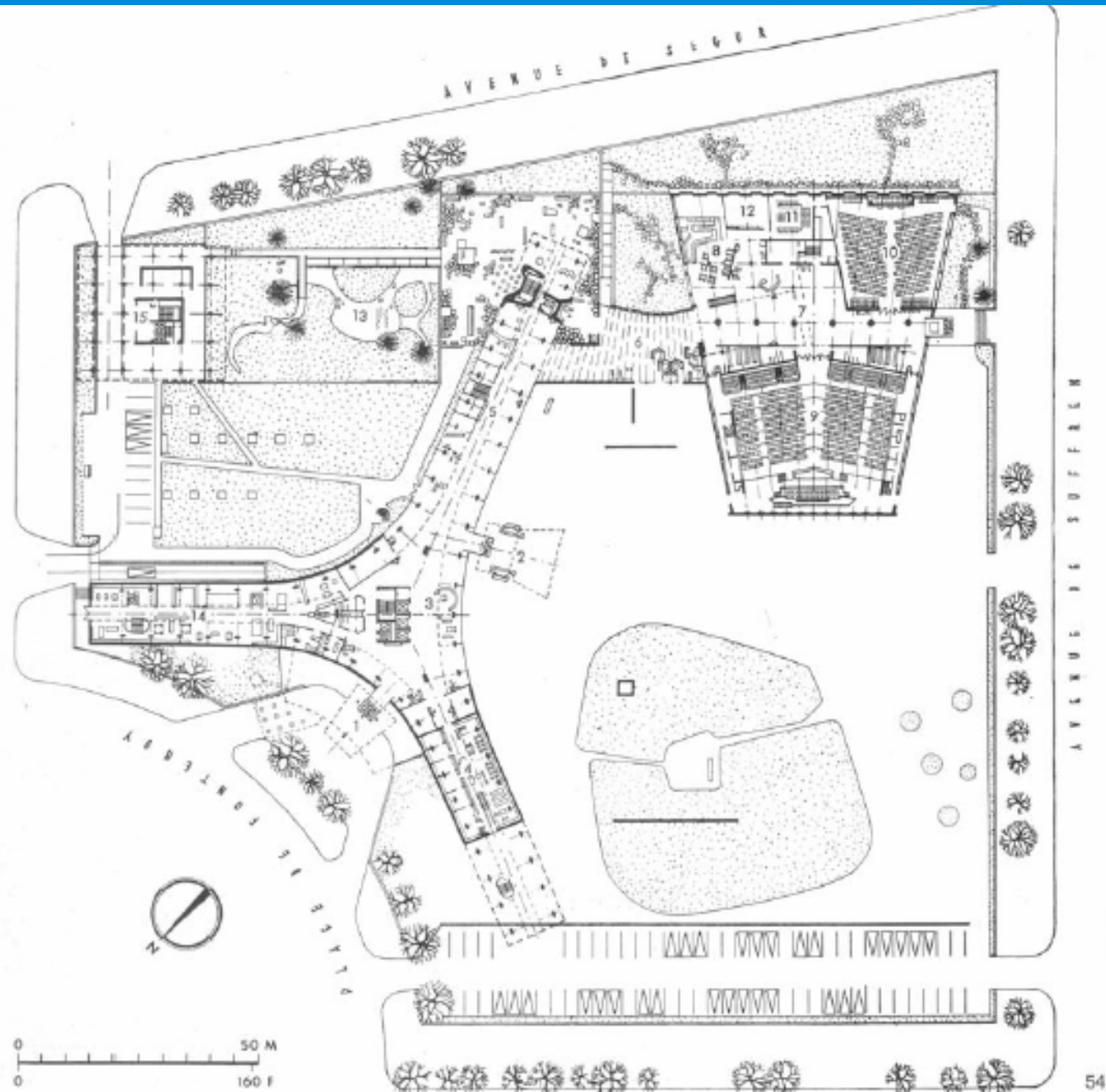







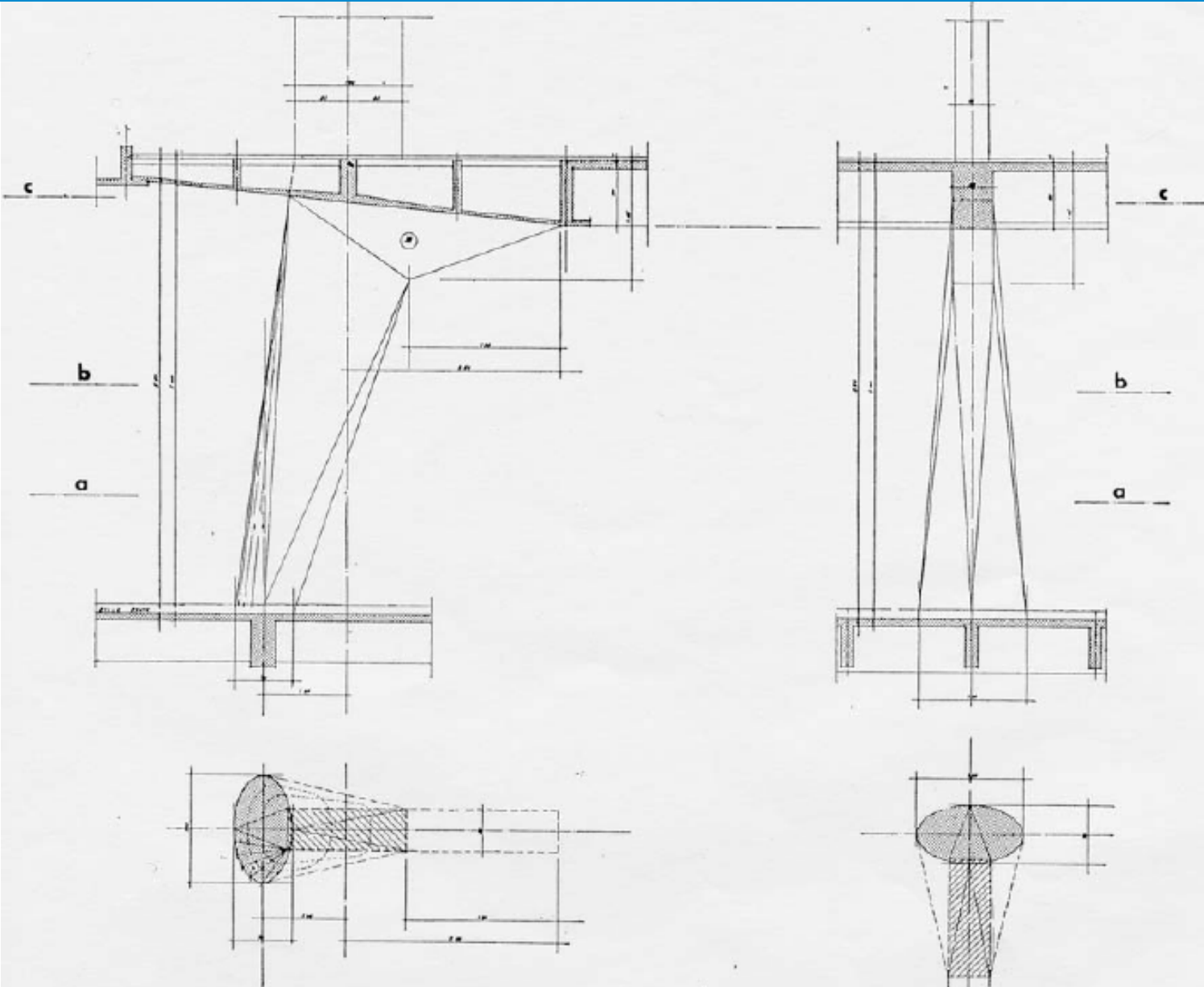

8

Base de sección elíptica cuyo eje mayor se dispone paralelo al edificio

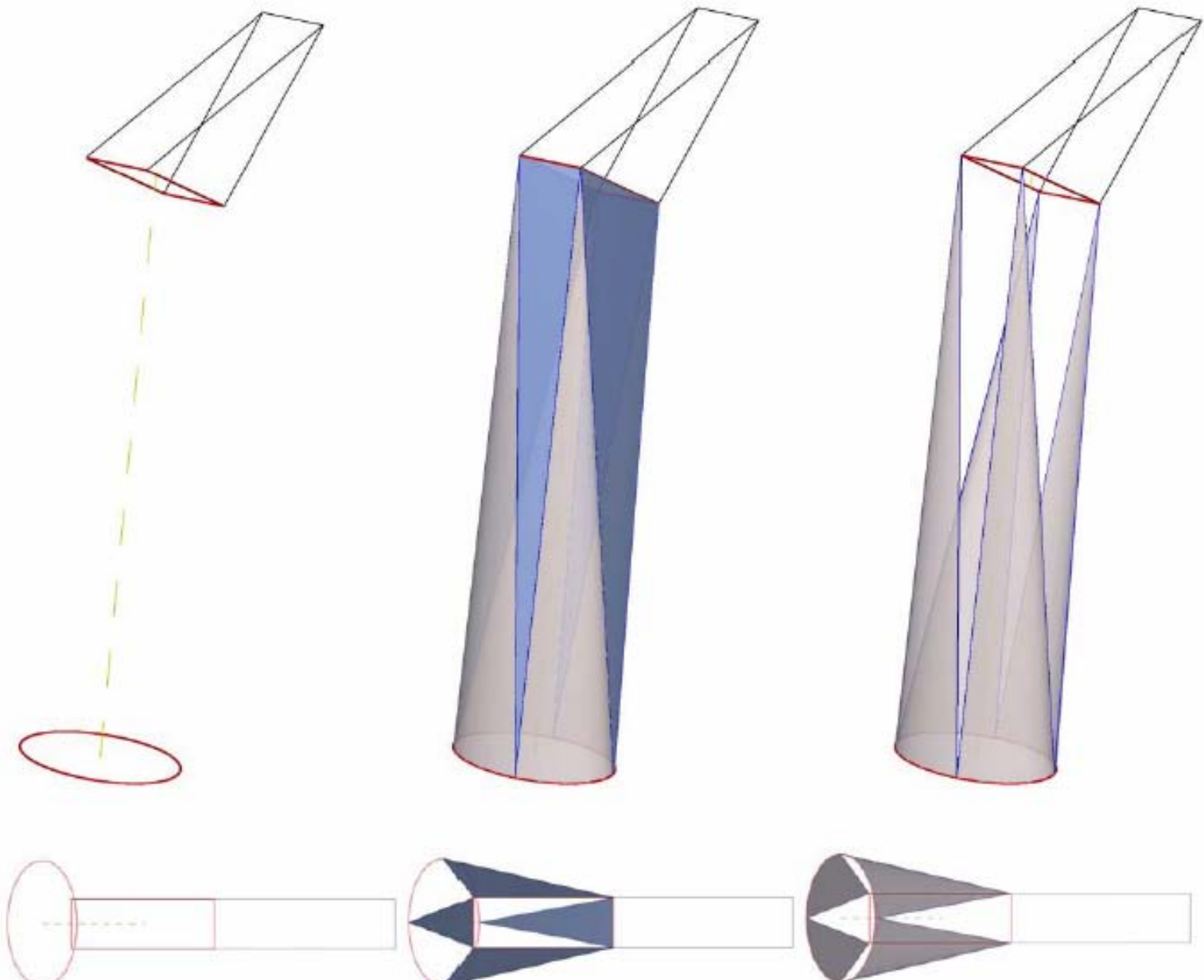

Construcción geométrica del fuste



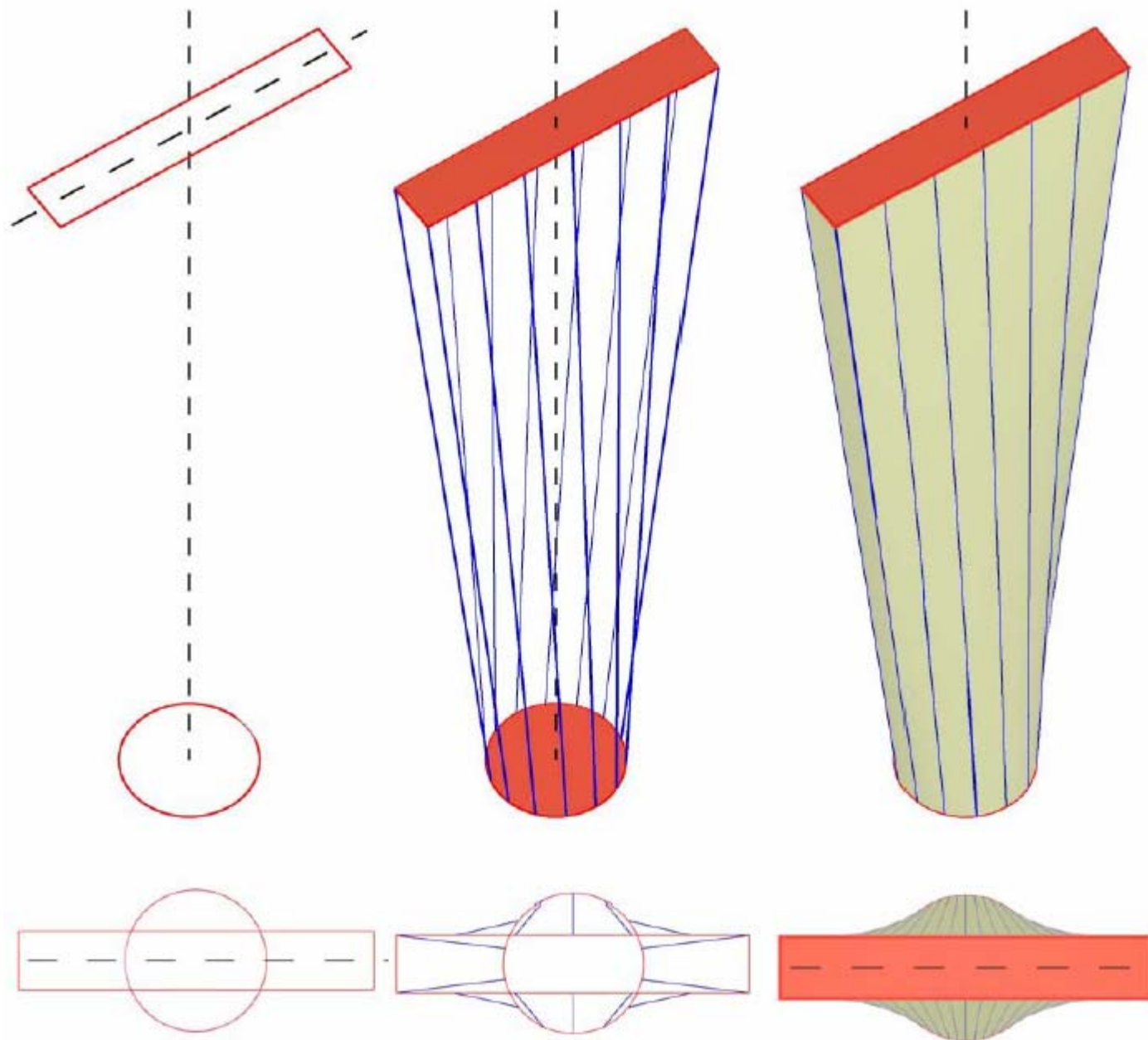



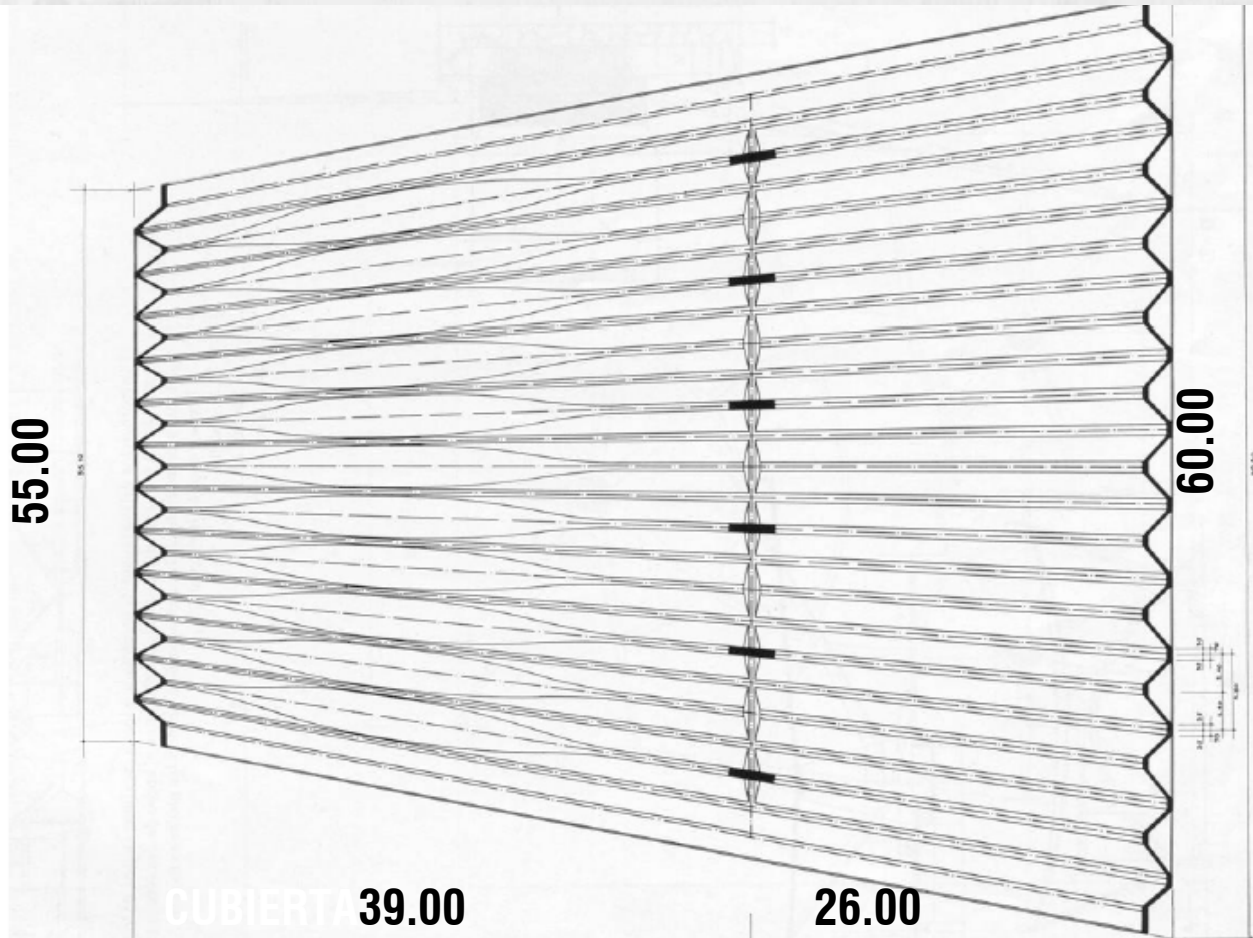
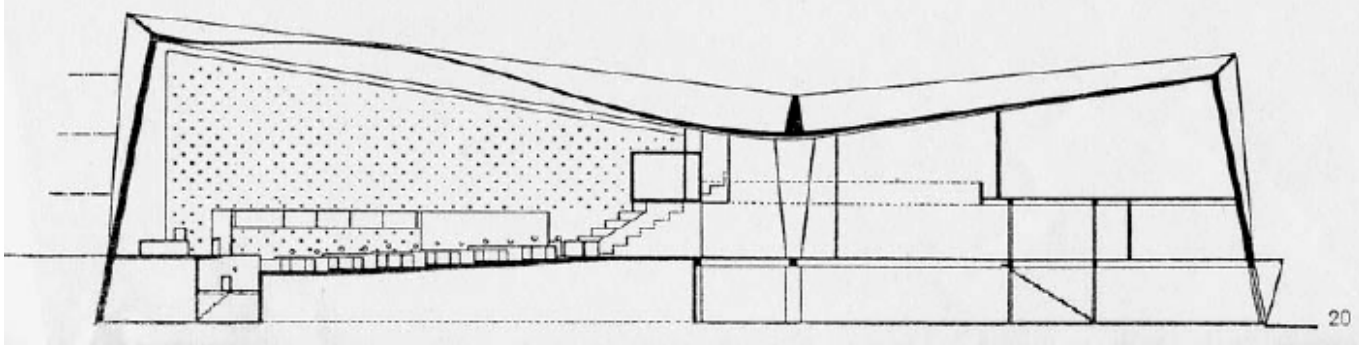

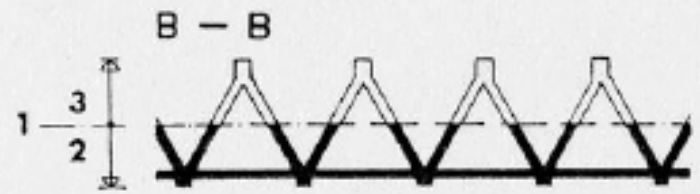

SECCIONES TRANSVERSALES



DIAGRAMA DE MOMENTOS





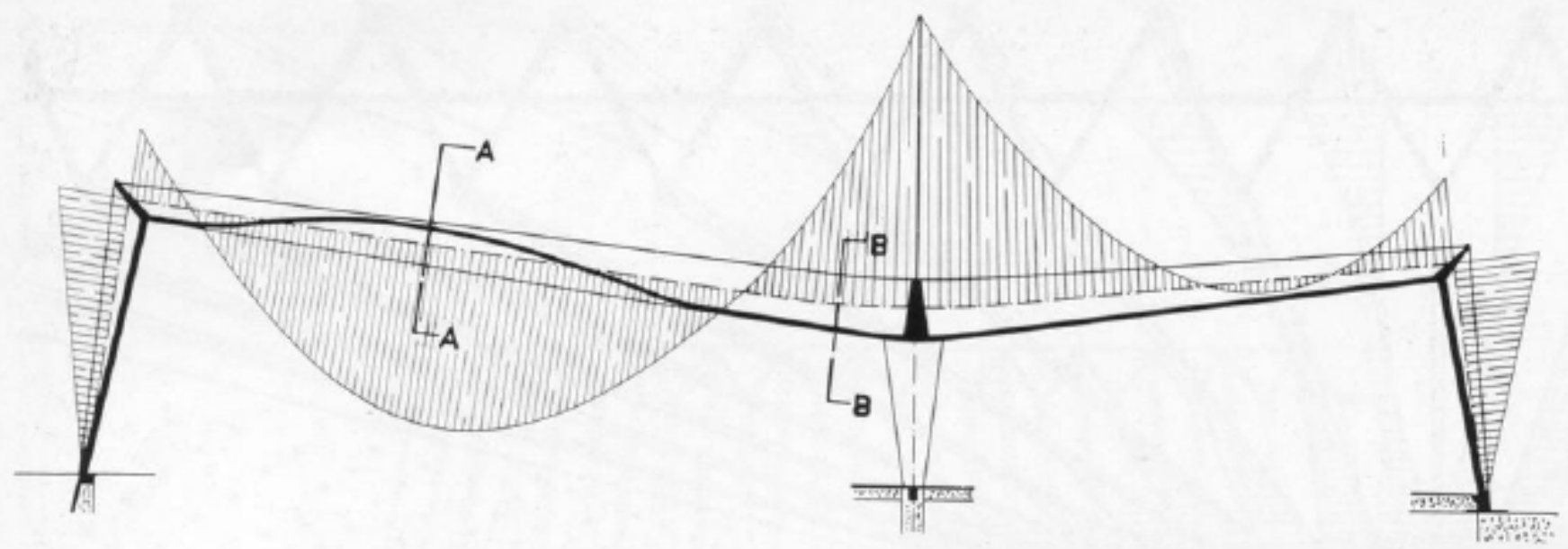
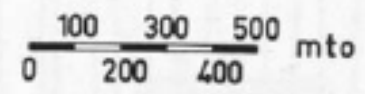

PLANTA

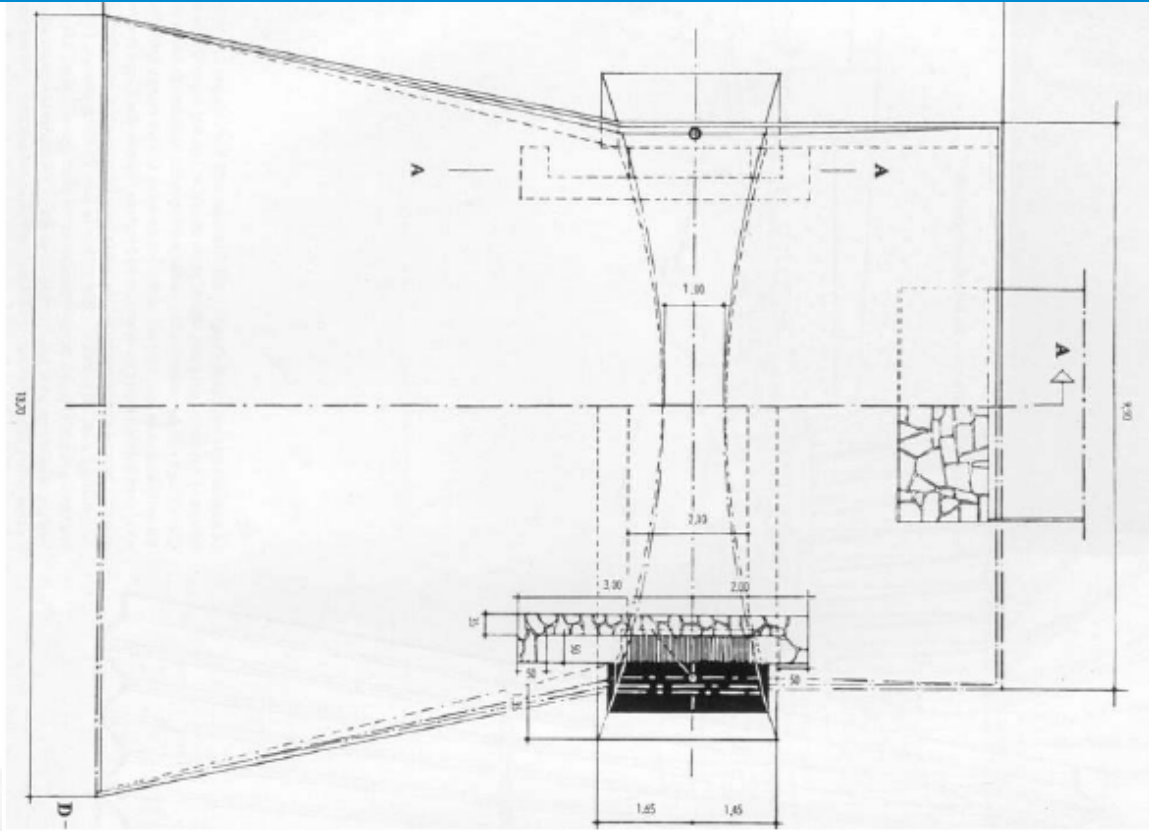

CORTE

